



TouchChat[®] Express

User's Guide: English

Dedicated and Non-Dedicated Devices

TouchChat Express 8 · 2nd Generation

TouchChat Express 10 · 2nd Generation

If you would like a Spanish version of this manual,
please visit <https://saltillo.com/support/downloads>.

Si desea una versión en español de esta guía, favor
visitar a <https://saltillo.com/support/downloads>.



Copyright and Trademark Information

© 2015-2021 PRC-Salttillo. Non-commercial reprint rights for clinical or personal use granted with inclusion of copyright notice. Commercial use prohibited; may not be used for resale. Contact PRC-Salttillo for questions regarding permissible uses.

AAC Language Lab®, Accent®, AeroSwitch™, AeroText™, ChatEditor™, ChatFusion™, ChatPoint™, ChatSMS™, ChatWrap®, CoreScanner™, Dialogue™, Empower™, Engage™, Essence®, Freedom Switch™, iSharePRC®, LAMP™, LAMP Words for Life®, Look®, Minspeak®, NovaChat®, NuEye®, NuPoint®, NuVoice®, PASS™, PRiO®, Realize Language™, Semantic Compaction™, Timocco-on-Accent™, TouchChat®, UNIDAD®, Unity®, Via®, VersaChat™, and VocabPC™ are trademarks of PRC-Salttillo.

AirDrop®, App Store®, Apple®, Apple Books®, FaceTime®, Guided Access®, iCloud®, iPad®, iPad Air®, iPad mini®, iPadOS®, iPad Pro®, iPhone®, iPod®, iTunes®, Lightning®, Mac®, Macintosh®, Safari®, Siri®, TouchID®, and TrueDepth® are trademarks of Apple Inc., registered in the U.S. and other countries and regions.

Acapela Group® and my-own-voice™ are trademarks of Acapela Group. Acapela Group, Copyright 2021. All rights reserved. Used with permission. The Acapela text to speech technology and the synthetic voices contained in this software are included free of charge for the usage by the end user but may be used solely for communication purposes and may not be sold, copied or otherwise exploited for any type of profit.

The *Bluetooth*® word mark and logos are registered trademarks owned by the Bluetooth SIG, Inc. and any use of such marks by PRC-Salttillo is under license.

Dropbox® is a registered trademark of Dropbox, Inc.

Google™, Google Drive™, Google Play™, Android™, and YouTube™ are trademarks of Google Inc.

iOS® is a trademark or registered trademark of Cisco in the U.S. and other countries and is used under license.

Microsoft® and Windows® are either registered trademarks or trademarks of Microsoft Corporation in the United States and/or other countries.

PCS® is a trademark of Tobii Dynavox LLC. All rights reserved. Used with permission.

The symbols used in this work are owned by n2y, LLC. Used with permission under license. © 2021.



VocalID™ is a trademark of VocalID, Inc.

The Voice Keeper and Almagu voices are intellectual property of Almagu.

Wi-Fi® is a registered trademark of Wi-Fi Alliance.

WordPower™ is a trademark of Inman Innovations, Inc. © 2001-2021; All rights reserved. Used with permission.

Contact Information

Manufacturer	EU Authorised Representative	EU Importer
		
Prentke Romich Company 1022 Heyl Rd Wooster, OH 44691 USA Tel.: +1 330 262-1984 · +1 800 262-1984 Fax: +1 330 262-4829 Email: info@prentrom.com Web: www.prc-salttillo.com/	Prentke Romich GmbH Karthäuserstr. 3 D-34117 Kassel Germany Tel.: +49 (0) 561 7 85 59-0 Fax: +49 (0) 561 7 85 59-29 Email: info@prentke-romich.de Web: www.prentke-romich.de/	Prentke Romich GmbH Karthäuserstr. 3 D-34117 Kassel Germany Tel.: +49 (0) 561 7 85 59-0 Fax: +49 (0) 561 7 85 59-29 Email: info@prentke-romich.de Web: www.prentke-romich.de/
UK Responsible Person and Importer	Authorised Representative in Australia	
Liberator Ltd "Whitegates", 25-27 High Street Swinestead, Lincolnshire NG33 4PA UK Tel.: +44 (0) 1733 370 470 Fax: +44 (0) 1476 552 473 Email: info@liberator.co.uk Web: www.liberator.co.uk/	Liberator Pty Ltd 265, Gilbert Street, Adelaide, SA 5000 Australia Tel: +61 (0) 8 8211 7766 Email: info@liberator.net.au Web: www.liberator.net.au/	

Document Version / Software Version

10144 Version 2.18 · 11/03/2021 / Software version 2.34

Applies to: Models TCE8.2, TCE10.2; dedicated and non-dedicated devices

Contents

Introduction	7
Safety Information: TouchChat Express	8
Identifying TouchChat Express 8 Features	10
Identifying TouchChat Express 10 Features	11
Charging the Device and Amplifier	12
Non-Dedicated Devices: Turning the iPad On and Off or Putting It to Sleep	14
Turning the iPad On and Off	14
Locking the iPad and Putting It to Sleep.....	14
Turning the Amplifier On and Off	15
Adjusting the Volume and Muting Sounds	16
Using the Touchscreen	17
Non-Dedicated Devices: Using the Home Button and Home Screen	18
Using the TouchChat App	19
Safety Information: TouchChat	19

Agreeing to the End User License Agreement	19
<i>Non-Dedicated Devices: Opening, Minimizing, and Closing the TouchChat App</i>	20
Finding the TouchChat Version	20
Working with TouchChat Menus.....	20
Working with Vocabulary Files.....	21
English Vocabulary Files	21
Spanish Vocabulary Files	24
Loading a Vocabulary File.....	25
Purchasing a New Vocabulary File.....	26
Copying a Vocabulary File	27
Creating a New Blank Vocabulary File.....	27
Renaming a Vocabulary File	28
Deleting a Customized Vocabulary File	28
Exporting Vocabulary Files to a USB Drive from Your Device.....	29
Importing a Vocabulary File from a USB Drive to Your Device	29
Importing Multiple Vocabulary Files from a USB Drive to Your Device.....	30
Choosing a Voice	31
Adjusting the Voice	32
Adding Voices in Additional Languages.....	32
Deleting a Voice Language	34
Creating Your Voice with Voice Keeper.....	36
Setting up Your VocalID™ Voice	37
Changing How a Word is Pronounced by a Voice.....	38
Using ChatEditor with TouchChat	39
Downloading and Installing ChatEditor	39
Configuring ChatEditor	39
Enabling Speech and Symbols in ChatEditor	40
Opening ChatEditor.....	40
Using ChatEditor to Create Instructional Materials.....	41
Transferring a Vocabulary File from ChatEditor to the Device using iTunes	42
Copying a Vocabulary File from the Device to ChatEditor using iTunes.....	42
Activating Edit Mode.....	43
Working with Buttons	43
Editing a Button.....	43
Changing a Button Label or Message.....	43
Changing the Pronunciation of a Word in a Button Message	44
Adding or Changing a Button Action	45
Removing or Changing the Order of an Action.....	45
Available Button Actions	46
Inserting Special Characters	48
Adding an Image to a Button: Enter a Label and Browse	49
Adding an Image to a Button: Search.....	50
Adding an Image to a Button: Select Categories	50
Adding an Image to a Button: Import.....	51
Adding an Image to a Button: Take a Picture	52
Changing the Skin Tone of People on Buttons in a Vocabulary.....	53
Changing the Skin Tone of People on a Specific Button.....	55
Creating a Camera Button	57
Resizing a Button.....	57
Changing a Button Style	58
Changing a Button's Basic Colors	58
Customizing a Button's Colors.....	59
Creating a Button to Link to a Page.....	60
Storing Text on a Button	61

Creating a Volume Control Button	61
Creating a Battery Status Button	62
Creating a Button to Show the Date and/or Time	62
Copying and Pasting a Button	63
Copying and Pasting the Same Button	64
Copying and Pasting a Button Style	64
Moving a Button	65
Hiding Multiple Buttons at Once	65
Hiding a Button	66
Changing Button Timing	67
Hiding and Showing Button Navigation Arrows	68
Adding Extra Space around Buttons	68
Working with Pages	69
Renaming a Page	69
Duplicating a Page	69
Loading Another Page	69
Creating a New Blank Page	70
Creating a New Page from a Navigate Action	70
Choosing a New Keyboard	71
Copying a Page from a Different Vocabulary File	72
Adding a Gesture to a Page	73
Overriding the Background Color of a Page	74
Working with Special Pages	75
Changing Your Home Page	75
Setting a Page as a Template	76
Creating a New Page from a Template	77
Trying to Delete Your Home Page	78
Editing an Abbreviation Expansion	79
Searching for a Word using Word Finder	80
Adding Acapela Vocal Smileys	81
Adding a Sound	81
Adding an Exclamation	81
Finding a Vocal Smiley	81
Example: Add a Smiley Face and Laugh Sound to a Button	81
Creating a Visual Scene	82
Selecting a Background Image	82
Adding Buttons	83
Creating a Whiteboard Page	84
Enlarging Text in the Speech Display Bar	86
Changing Text Size or Number of Lines in the SDB	86
Creating a Tap Action	86
Highlighting Words as They are Spoken in the SDB	87
Highlighting Words as They are Spoken during a Telephony Call	89
Setting up Switch Scanning in TouchChat	90
Setting up One or Two Switches	90
Using the TouchChat Scanning Settings	91
Using Auto-Scan	91
Selecting the Scan Pattern	91
Including the Speech Display Bar (SDB) in Scans	92
Configuring Empty Cells Scans	92
Setting Scan Timing	92
Configuring Re-scans	92
Turning on Auto Restart	92

Setting Auditory Scan	92
Choosing and Adjusting a Prompt Voice	92
Blocking and Restoring Access to the Editing Menus.....	93
Working with Profiles.....	94
Creating and Saving a Profile.....	94
Loading a Profile by Navigating Menus	94
Loading a Profile by Tapping a Button.....	94
Renaming or Deleting a Profile.....	95
Modifying a Profile	95
Changing Screen Orientation	96
<i>Non-Dedicated Devices:</i> Locking and Unlocking Screen Orientation in Control Center	96
Changing TouchChat Settings.....	97
Analyzing Language Development.....	102
Using the Realize Language Website	102
Turning on Data Logging from Your Device.....	103
Creating a Privacy Password	103
<i>Non-Dedicated Devices:</i> Uploading Data for Analysis	104
<i>Dedicated Devices:</i> Manually Uploading Data for Analysis	104
Clearing Usage Data	105
Changing or Removing Your Privacy Password	106
Adding a Webhook Event to a Button.....	107
Terms Used in This Section	107
Adding a Webhook Event.....	108
<i>Non-Dedicated Devices:</i> Viewing TouchChat and Another App Side-by-Side	109
Telephony: Using the TouchChat App to Make Phone Calls	110
Connecting to a Computer for the First Time	112
<i>Non-Dedicated Devices:</i> Updating the TouchChat Application Software	113
Updating the Device Software.....	114
<i>Non-Dedicated Devices:</i> Backing up Vocabulary Files.....	114
Backing up a Customized Vocabulary File using iTunes	114
Backing up a Customized Vocabulary File using iShare.....	115
Backing up a Customized Vocabulary File using AirDrop®, Google Drive™, or Email	116
Backing up a Customized Vocabulary File using Dropbox®	116
Backing up and Restoring Device Files	117
Backing up the Device	117
Restoring the Device	117
<i>Non-Dedicated Devices:</i> Using iPad Features	118
Identifying iPad Status Icons	118
Using Control Center.....	119
Adjusting Screen Brightness.....	119
Using Accessibility Features	120
Turning on Accessibility Features.....	120
Setting up an Accessibility Shortcut	120
Setting up and Using Guided Access	121
Turning Guided Access On.....	121
Configuring Guided Access Settings	121
Setting up and Starting a Guided Access Session	122
Ending a Guided Access Session	122
Syncing with iTunes.....	123
Setting up and Using iPad Switch Scanning.....	124
Enabling Scanning.....	124
Defining the Switches.....	124
Setting the Scanning Style	125
Auto Scanning	125

Manual Scanning	125
Single Switch Step Scanning	125
Additional Timing Options	126
Configuring Additional Scan Settings	126
Using Keyboards	128
Using On-screen Keyboards	128
Using the Apple Wireless Keyboard	129
Using an External Keyboard with TouchChat	129
Entering and Modifying Text	130
Typing Text	130
Working with Predictive Text	130
Correcting Misspelled Words	130
Modifying Text	131
Using Shortcuts	131
Dictating Text	131
Organizing Apps and Changing Wallpaper	133
Setting the Date and Time	134
Making an In-App Purchase	134
Playing a Song from TouchChat	135
Using SocialChat	135
Setting up a Button to Play a YouTube™ Video	136
Setting up a Button to Open an App	137
Searching Apps	138
Changing the iPad Language and Word Prediction Dictionaries	139
Setting up Restrictions	139
Attaching a Strap	140
Positioning the Stand	142
Removing the Handle	142
Attaching a Wheelchair Mounting Plate	143
Replacing the Rubber Boot	144
Cleaning and Disinfecting Your Device	145
Routine Cleaning and Disinfecting	145
Disinfecting TouchChat Express and Accessories for Multiple Users	146
Warranty	147
Appendix A: Advanced Grammar Features	148
Creating a Grammar Button	148
Identifying Parts of Speech	149
Creating a Grammar Rule Button	150
Using Your Grammar Rule Button	151
Clearing a Grammar Rule	151
Appendix B: Compliance Information	152

Introduction

TouchChat® Express features a reusable, protective case. The rubber boot and plastic shell provide protection while the amplifier delivers high quality audio output. The handle provides optimal portability. This user's guide offers step-by-step instructions for setting up and using your TouchChat Express device. Additional information and support are available.

Support articles can be found on the Saltillo website:

<https://saltillo.com/support>

Manuals can be found on the Saltillo website:

<https://saltillo.com/support/downloads>

Training opportunities can be found on the Saltillo website:

<https://saltillo.com/training>

For Saltillo product operational or technical support:

If you need assistance in setting up, using, or maintaining your TouchChat Express device or if you experience problems, please contact us by phone or email.

Phone: 1-800-382-8622

Email: service@saltillo.com

Trouble Tickets:

<https://saltillo.com/tt/>

For Realize Language™ website support:

support@realizelanguage.com

If you have a dedicated device:

A dedicated TouchChat Express device is set up for communication only. Your funding source requires that your device be locked when shipped. Guided Access® is turned on, other restrictions are in place, and you will not have access to apps. If you wish to enable additional features, please contact Saltillo Sales.

If you have a non-dedicated device:

This user's guide covers iPad® basics. For detailed instructions on using all iPad features, refer to the *iPad User Guide*, available from any of these sources.

Source	How to Find
Safari®	Open Safari and go to https://support.apple.com/guide/ipad . <i>Hint: Add an icon for the iPad User Guide to the Home screen. Tap  and then tap Add to Home Screen.</i>
Apple Books®	Open the Books app, search for iPad User Guide , and tap Get .
Internet	Go to https://support.apple.com/guide/ipad/welcome/ipados

Safety Information: TouchChat Express

Emergencies

- ⚠ This device is not intended to be an emergency call device or sole communication aid.

Cleaning, Maintaining, and Servicing

- ⚠ Do not attempt to service or maintain the device while it is in use. Disconnect the charger and turn off the device before cleaning or disinfecting the device.
- ⚠ If your device or an accessory is damaged, call Service for assistance. Do not attempt to make repairs yourself.

Accessories

- ⚠ Do not use accessories, detachable parts, or materials not described in this manual.
- ⚠ Do not use accessories, detachable parts, or materials in any other way than described in this manual.

Mounting and Positioning

- ⚠ Any mounts used, including switch mounts, should be fitted by a qualified person. Failure to install the mounting system according to the manufacturer's instructions may result in an injury to the user. Be certain that the user's view is not obstructed by the mounting.
- ⚠ Analysis of positioning by a qualified person is required to prevent repetitive stress injuries to the user.
- ⚠ Use your device and phone safely while texting. Do not text while performing another task or activity. See the phone manufacturer's manual for safe mounting and placement.

Vision and Hearing

- ⚠ The communication partner should ensure that the user takes frequent breaks to avoid eye strain.
- ⚠ Consult your vision care provider about device positioning considerations for the user.
- ⚠ Excessive volume or sound pressure level when using earphones or headphones can cause hearing loss over extended periods of time. Set the volume at a low level and increase it only enough that you can hear comfortably.

Ports and Connectors

- ⚠ Keep the device ports and mating cable connectors clean so that they make the best possible contact and are able to maximize the service life of your device. Dirty cable connectors will transfer the contaminate to the mating connector on the device and may degrade performance.
- ⚠ If your device has been exposed to water, the USB port must be completely dry before a USB cable is inserted into it. To remove moisture from the USB port, shake the device several times with the USB port facing downward, and then use a microfiber cloth to wipe the device dry. You should then check the USB port area again. If moisture is still visible in the USB port, repeat the shaking and drying procedure.
- ⚠ Do not try to force a connector into a port. Be sure you are inserting the connector into the correct port and that you have the connector turned so that it matches the orientation of the port.

Small Parts, Cords, Cables, and Straps

- ⚠ Cords, cables, and straps are potential entanglement or strangulation hazards. Please consider this prior to placing these items with device users.
- ⚠ On a regular basis, visually inspect cables, cords, and connectors for damage or wear, especially where they are subject to extra stress. Cables and cords can become frayed or damaged from heavy use or with age. For example, a frayed cable could cause a battery charger/power adapter to short-circuit, posing a hazard to the user. If any cable, cord, or connector is damaged or worn, call Service for a replacement.
- ⚠ When unplugging a cable or cord, grasp the connector instead of the cable or cord itself to avoid damage or wear.
- ⚠ Always use cables, whether for charging or transferring vocabulary files, according to the instructions in this manual.
- ⚠ Small parts could present a choking or other hazard.
- ⚠ If the stand is removed, it becomes a potential hazard for poking an eye. Store it in a safe location.
- ⚠ The USB flash drive could be a choking hazard. Store it in a safe location when not in use.
- ⚠ The stylus is a potential hazard for poking an eye.

Screen

- ⚠ Do not use the device if the screen is cracked or broken.
- ⚠ Do not remove the touchscreen overlay from the device. The overlay protects the device user from any glass shards in case of screen breakage.

Interference

- ⚠ When operating this device in a medical environment, do not use with any product that is not medically approved. Follow all rules for appropriate wireless device use.
- ⚠ Do not use this device close to sources of RF/RFID radiation or you may encounter interference. Move away, if possible, from the source of the interference.

Water

- ⚠ If your device has been exposed to water, the USB port must be completely dry before a USB cable is inserted into it. To remove moisture from the USB port, shake the device several times with the USB port facing downward, and then use a microfiber cloth to wipe the device dry. You should then check the USB port area again. If moisture is still visible in the USB port, repeat the shaking and drying procedure.
- ⚠ Your device is intended for use in normal communication situations. It is not waterproof. Do not spray or splash liquid directly on the device and use extreme caution when using it around water. As with most electronic devices, you should never use the device when you are actually in the water (for example, a pool or bath).

Batteries and Charging

- ⚠ Use only the battery charger provided with your device.
- ⚠ Amplifier batteries and tablet batteries are not replaceable by the customer.
- ⚠ Do not place the device where it is difficult to operate or difficult to disconnect from the charger.
- ⚠ Always follow the instructions in this manual when charging your device.
- ⚠ Do not insert any object into the charging port. This can result in damage to the port.
- ⚠ To avoid electric shock and damage to your device, do not charge the device while it is wet or in an area where it could get wet. Do not handle the device, charger, or cords with wet hands.
- ⚠ Locate the device in a safe, dry location while charging. Do not charge the device outdoors.
- ⚠ Keep the charger away from water and do not allow water or any other liquid to be spilled on it.
- ⚠ The battery charger country plug adapters could be choking hazards when not attached to the charger. Store the adapter that is not currently in use in a safe location.
- ⚠ If the charger, cable, or cord is damaged, call Service for a replacement.

Heat

- ⚠ Do not place the device in an appliance such as a microwave or oven, near an open flame, or on or near a source of heat such as a stove or heater.
- ⚠ Do not leave the device in a hot vehicle for a prolonged period.

Touching the Surface

- ⚠ While the device is charging, touching the surface of the device with broken skin may aggravate a wound.
- ⚠ While the device is charging, infants or high-risk groups should not touch the surface of the device if there is a chance of burning the skin.

Implantable Medical Devices

A minimum of six (6) inches should be maintained between a handheld wireless mobile device and an implantable medical device, such as a pacemaker, implantable cardioverter defibrillator, vagus nerve stimulator, shunt, or stent, to avoid potential magnetic interference with the medical device. Persons who have such devices:

- Should ALWAYS keep the mobile device a minimum of six (6) inches from their implantable medical device;
- Should not carry the mobile device in a breast pocket;
- Should move the mobile device away from themselves immediately if there is any reason to suspect that it is interfering with the implantable medical device;
- Should read and follow the directions from the manufacturer of the implantable medical device. If you have any questions about using your wireless mobile device with an implantable medical device, *consult your health care provider.*

Identifying TouchChat Express 8 Features

Rear View

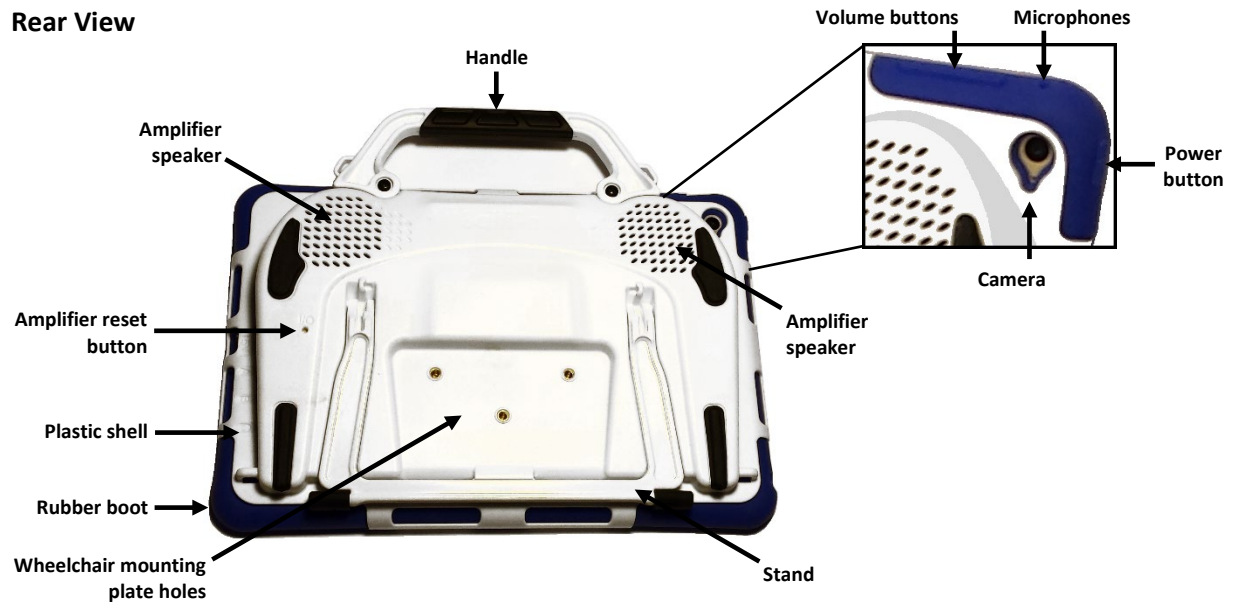

Front View



Side View

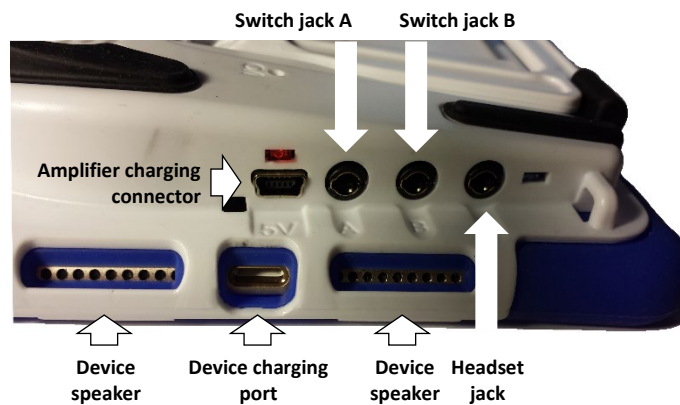

Identifying TouchChat Express 10 Features

Note: The TouchChat Express 10 device is no longer manufactured.

Rear View

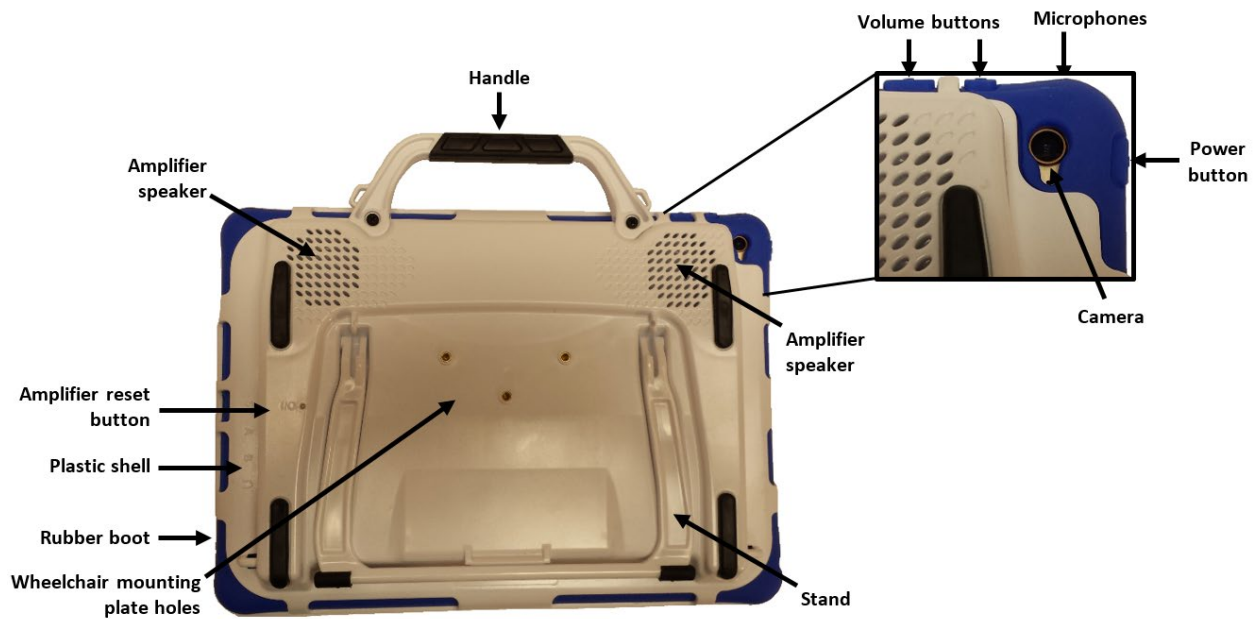

Front View



Side View

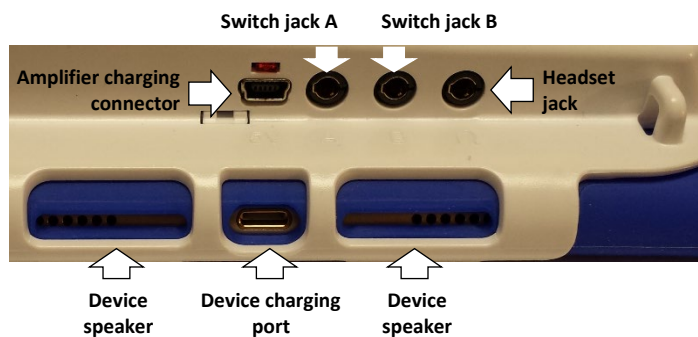

Charging the Device and Amplifier

Connecting the Charger

You received a battery charger with your TouchChat Express. One end of the charger plugs into a wall outlet—a surge protector is recommended. The other end has two connectors, allowing you to charge the device and amplifier at the same time.



- One connector plugs into the amplifier.
- The other connector is a receptacle for the USB cable that came with your device.

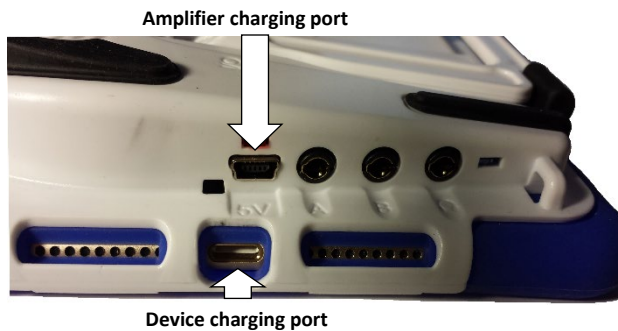

Use only the battery charger or backup charger provided with your device.



Cords and cables are potential entanglement or strangulation hazards. Please consider this prior to placing these items with device users.



Locate the device in a safe location while charging.



Batteries are not replaceable by the customer.

Using the Backup Charger

A backup charger came with your device. Use that charger only if necessary in an emergency. The backup charger can only be used with the device. *Do not use it to charge the amplifier.*

To charge the device and amplifier:

Hint: We suggest charging both the device and the amplifier each night.

1. Tap the device's power switch to turn the display light off.
2. Plug the charger's amplifier connector into the amplifier.
3. Plug one end of the USB cable that came with your device into the device and the other end into the charger's receptacle.
4. Plug the other end of the charger into a wall outlet or surge protector.
5. The amber light next to the amplifier's charging port will flash during charging and remain on when the amplifier is fully charged.

When the device and amplifier are fully charged:

1. Unplug the connectors from the device and amplifier.
2. Unplug the charger from the wall outlet or surge protector (*optional*).
3. Tap the device's power switch to turn the display light on.

Checking Battery Status

To check the battery level or charging status at any time, create a button with the Battery Status action or find and tap a battery status button in your vocabulary. For more information, see “Creating a Battery Status Button” on page 62.

Non-Dedicated Device: Checking Battery Status of the Device Only

To check the iPad’s battery level or charging status at any time, press the **Home** button. The current battery status is displayed in the top right corner of the screen. *The battery status indicator only shows the battery level or charging status of the iPad, not the amplifier.*

Non-Dedicated Device: Extending Battery Life

To extend battery life, you can dim the screen. Choose **Settings > Display & Brightness** and drag the slider.

Disposing of the Device or the Amplifier Battery

 **Device Disposal:** Please dispose of your device in accordance with your local, state, and/or federal electronic recycling laws.

 **Battery Disposal:** If the battery in your amplifier needs to be replaced, dispose of the old battery in accordance with your local, state, and/or country regulations.

Non-Dedicated Devices: Turning the iPad On and Off or Putting It to Sleep

The power button allows you to turn the iPad on and off or lock the iPad and put it to sleep.



Turning the iPad On and Off

To turn the iPad on, hold down the power button until the Apple® logo appears on the screen.

To turn the iPad off, hold down the power button for a few seconds until “slide to power off” appears on the screen. Then drag the **slide to power off** text.

Locking the iPad and Putting It to Sleep

You can lock the iPad and put it to sleep when you are not using it. Locking the iPad turns off the display, turns off touch capability, and saves battery power. The iPad is still able to receive calls, text messages, alarms, and notifications. You can also listen to music and adjust the volume.

To lock the iPad:

To lock the iPad, press the power button. If you do not touch the screen for two minutes, the iPad will lock automatically. To change the auto-lock time, choose **Settings > Display & Brightness > Auto-Lock**.

To unlock the iPad:

TouchChat Express 8: Press the **Home** button or the power button.

TouchChat Express 10: Press the **Home** button or the power button, and then drag the **slide to unlock** text that appears on the screen. (*Note:* The TouchChat Express 10 device is no longer manufactured.)

To add a passcode:

If you want to require a passcode to unlock the iPad, choose **Settings > Touch ID & Passcode**. Then use the passcode options to set the passcode.

Turning the Amplifier On and Off

The device and amplifier communicate using a Bluetooth® connection. Typically, the amplifier should be left on. During air travel and in some medical facilities the Bluetooth option is required to be turned off. When the amplifier is off, speech is still present but comes from the device's internal speaker.

Non-Dedicated Devices: Turning Bluetooth Off

1. Open the device's **Settings** menu.
2. Turn **Bluetooth** off.

Non-Dedicated Devices: Turning Bluetooth On

1. Open the device's **Settings** menu.
2. Turn **Bluetooth** on.
3. Choose the amplifier from the list of options under "Devices" to the right of "Bluetooth".
4. Close the Settings menu.
5. The blue light on the edge of the amplifier should be solid blue.

Connecting Bluetooth to the TouchChat Software

1. Open the TouchChat app.
2. Open your vocabulary file and choose **Menu > Settings**.
3. Scroll down to the Amp Connect section.
4. Choose **Select Amp** and choose your amplifier.

Turning the Amplifier On and Off

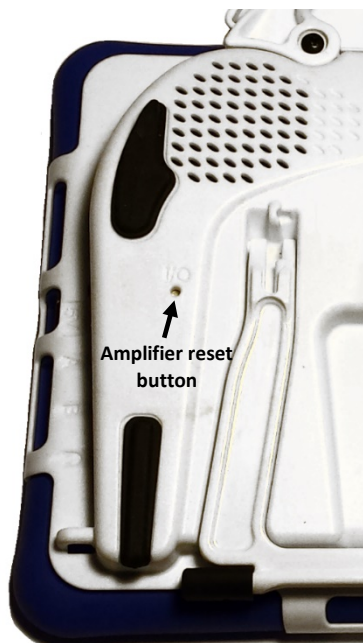

To turn the amplifier off: Press and hold the amplifier reset/power button (labeled "I/O") until both the amber and blue lights come on. When the amber light goes out, let go of the button.

Hint: The button is recessed. Use the tip of a pen when you need to press it. Do **not** use an object with a sharp point, such as a pin; it could damage the button.

To turn the amplifier on: Press the reset/power button for a second. The blue light will flash to indicate the amplifier is on.

If the speakers/amplifier no longer produce sound or sound is limited to the device's speakers only:

- Make sure the amplifier has been charged.
- Check the blue LED on the side of the amplifier. If it is flashing, the amplifier needs to be reconnected.
- Make sure Airplane Mode is off.

Adjusting the Volume and Muting Sounds



Excessive volume or sound pressure level when using earphones or headphones can cause hearing loss over extended periods of time.

Using the Volume Buttons

The volume buttons are located on the edge of the device. Pressing one button increases the volume and pressing the other lowers the volume.

The volume buttons fit into a slot in the TouchChat Express plastic shell. The rubber boot for some models covers the two volume buttons with a single button. Press one side of the button to increase the volume and press the other side of the button to decrease the volume. By pressing a side, you are pressing the device button underneath.

To mute sound, press and hold the Volume Down button.

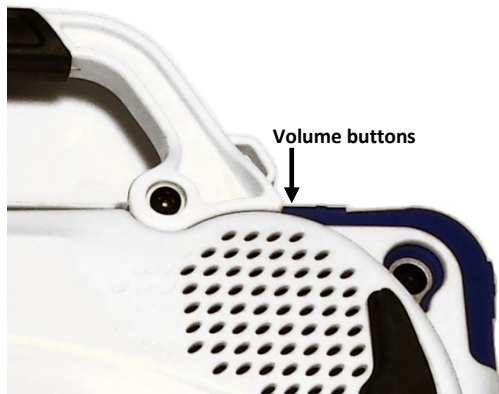

TouchChat Express 8

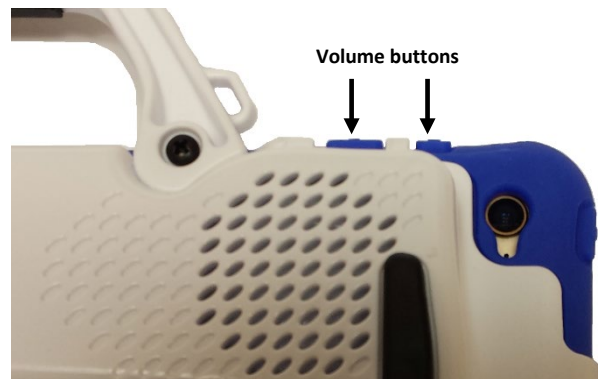

TouchChat Express 10

(The TouchChat Express 10 device is no longer manufactured.)

Non-Dedicated Devices: Using Control Center

When the iPad is locked or when you are using another app, swipe up from the bottom edge of the screen to open Control Center. Do Not Disturb, also available in Control Center, is an easy way to keep the iPad silent. For additional information, see “Using Control Center” on page 119.

Using the Touchscreen

Your device comes with a capacitive touchscreen. It responds best to a light touch from the pad of your finger.

Important! Using excessive force or a metallic object when pressing on the touchscreen may damage the tempered glass surface.

Stylus

A stylus was provided in your TouchChat Express package. If you prefer to get your own stylus, it must be compatible with a capacitive touchscreen.

Note: The stylus provided has an opening on the end for attaching to you or the device. Find a chain, string, or lanyard that matches your personal style.



The stylus is a potential hazard for poking an eye.

Non-Dedicated Devices: Using the Home Button and Home Screen

Press the Home button to display the Home screen at any time.

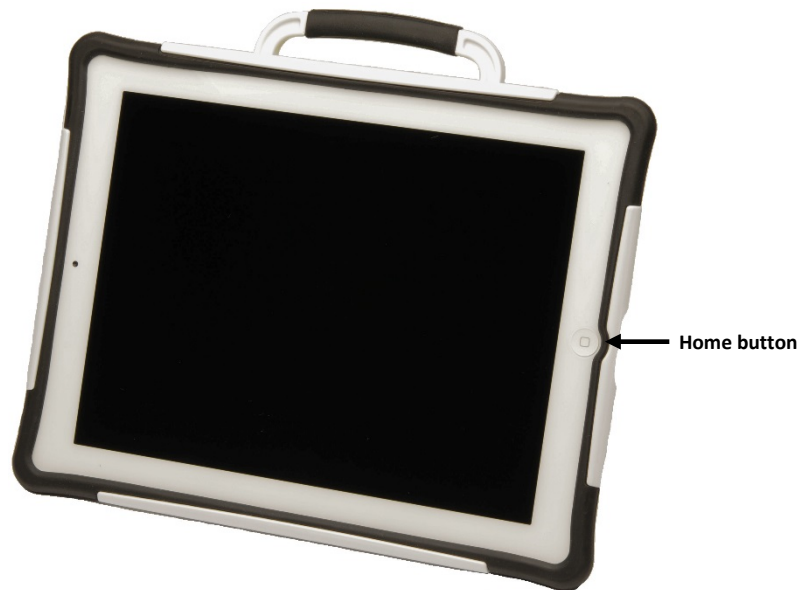

All the apps that came on your iPad, plus any apps you download, are available from the Home screen. To open an app, simply tap it. To see the apps that you have opened, double-press the **Home** button and swipe left or right. To display the Home screen at any time, press the **Home** button. Swipe left or right to go to other screens.

To use Siri® (on iPad 3rd generation or later), press and hold the **Home** button.

You can also press the **Home** button quickly three times to turn accessibility features on or off.

To take a screen shot, press and hold the power button and **Home** button at the same time.

Note: On iPad models with Touch ID®, you can use the sensor in the Home button, instead of using your passcode or Apple ID password, to unlock the iPad or make purchases in the iTunes Store, App Store, and iBooks Store. You can also use the Touch ID sensor for authentication when using Apple Pay to make a purchase from within an app.

Using the TouchChat App

TouchChat is intended for individuals who have difficulty using their natural voice. TouchChat is designed for individuals with Autism, Down Syndrome, ALS, apraxia, stroke, or other conditions that affect a person's ability to use natural speech.

Safety Information: TouchChat

This app is intended for use in normal communication situations. When using the app, keep the following safety guidelines in mind.

- ⚠ This app is not intended to be an emergency call app or a sole communication aid.
- ⚠ Use the app safely while texting. Do not text while performing another task or activity.
- ⚠ The communication partner should ensure that the user takes frequent breaks to avoid eye strain.
- ⚠ Consult your vision care provider about positioning the device for the user to view the app.
- ⚠ When adjusting volume in the app, excessive volume or sound pressure level when using earphones or headphones can cause hearing loss over extended periods of time. Set the volume at a low level and increase it only enough that you can hear comfortably.
- ⚠ If the app stops functioning, contact Service for assistance.

Agreeing to the End User License Agreement

After you open the app the first time, a message asks you to agree to the End User License Agreement. If necessary, tap the website link in the message to get started with the app.

Non-Dedicated Devices: Opening, Minimizing, and Closing the TouchChat App

To open the TouchChat app:

Go to the Home screen and tap the TouchChat app logo.

Note: The TouchChat app logo will vary depending on the specific TouchChat app you have.

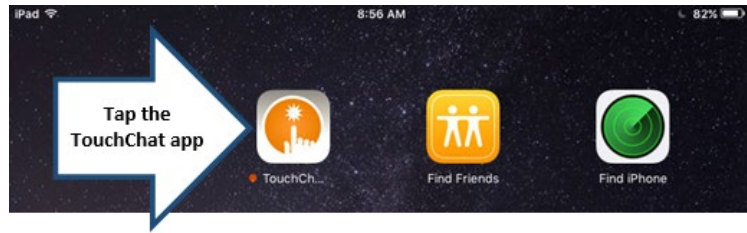

To minimize the TouchChat app:

There is a difference between minimizing the app and closing it. Tap the Home button to minimize the app. The app will continue to run in the background.

To close the TouchChat app:

1. Tap the **Home** button on the device. This will minimize, not close, the app.
2. Double-tap the **Home** button. This will open the multi-tasking screen.
3. Drag the app up from the multi-tasking screen.
4. Once the app is closed, press the **Home** button to return to the Home screen.

Finding the TouchChat Version

1. Tap **Vocab**.
2. Tap Choose New Vocab.
3. The software version will be displayed at the bottom of the screen.

Working with TouchChat Menus

To access the TouchChat menus, tap **Menu**. Menu options depend on where you are in the application and whether Edit Mode is turned on. For example:

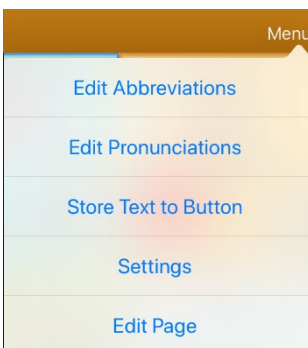

Menu options with Edit Mode turned off

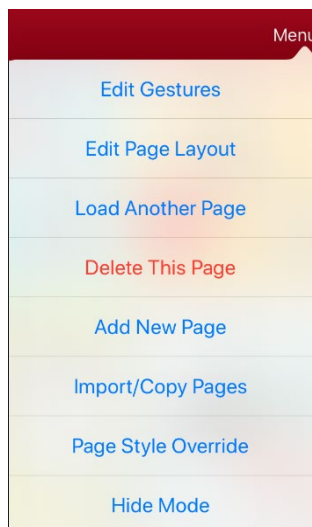

Menu options with Edit Mode turned on

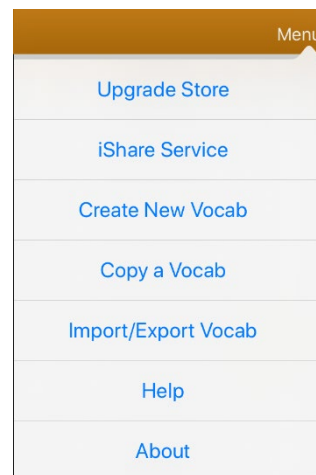

Menu options after choosing Vocab > Choose New Vocab > Menu

Working with Vocabulary Files

TouchChat provides a variety of pages that have different button layouts. Each set of pages, or vocabulary set, is called a vocabulary file. TouchChat-provided vocabulary files have locks in front of them indicating they cannot be deleted. This section provides brief descriptions of the available vocabulary files.

English Vocabulary Files

Note: When the system language is set to English, the English vocabulary files will be listed individually when you tap Choose New Vocab and the Spanish vocabulary files will be located in a folder labeled “Spanish”. When the language is set to Spanish, the Spanish vocabulary files will be listed individually when you tap Choose New Vocab and the English files will be located in a folder labeled “Inglés”.

4-Basic

4-Basic offers just that, a basic vocabulary option with 4 buttons per page.

Communication Journey: Aphasia

“Communication Journey: Aphasia” is a vocabulary file containing features and vocabulary designed to support people with aphasia. It was developed by Lois Turner (SLP), Anne MacCallum (SLP) and Sarah Gauthier (SLP Assistant) in consultation with a group of speech-language pathologists who work exclusively with people with aphasia and brain injuries. All the participants work at CAYA (Communication Assistance for Youth and Adults) and the GF Strong Rehabilitation Centre in Vancouver, BC, Canada. The framework of the file was derived from the Life Participation Approach to Aphasia from the Aphasia Institute in Toronto, Canada. The pages were created to facilitate participation in daily activities and to promote social links.

Aphasia, a disorder caused by damage to the parts of the brain where language is stored, may affect the ability to comprehend language, to express oneself, to read, or to spell and write. “Communication Journey: Aphasia” can easily be adapted for use by people with different types of aphasia and a range of cognitive levels and degrees of severity.

Symbols, photographs, visual scenes, videos, or words can be used on the message, topic, and script pages. Included are pages that facilitate supported communication techniques, self-advocacy, directing care, and repair of communication breakdowns. Types of information typically included in communication books—such as pain and emotion scales, maps, and templates for personal information and life stories—are also incorporated into the vocabulary file. Specialized features include variable “rate of speech” and “pause between words”. Grid size and vocabulary are easily customized to reflect and support the life experiences of the person with aphasia.

Although this vocabulary file contains starting-point vocabulary commonly required by adults with aphasia, it *must* be customized. Each person has a unique history, and the file must reflect that person’s life, experiences, and abilities.

MultiChat 15

MultiChat 15 features a 15-button layout and is available in three versions: one for school-aged individuals with emerging language skills, one for adolescents, and one for adults. There are multiple forms of communication available in this program: sentences, phrases, individual words, recordings for story-telling, and visual scenes. Also included are interactive play and reading pages, social pages and a News-2-You starter page for the weekly newspaper’s vocabulary. There are symbols on every button with the exception of several core words.

myCore

myCore is a combination of core and phrase-based vocabulary geared toward individuals who have literacy skills.

myQuickChat

myQuickChat is an introductory communication system geared toward child and adult AAC users with complex communication needs. myQuickChat is available for both kids and adults in 4, 8, and 12 locations, each with an identical 16-location Support Master Home Page. myQuickChat was created to offer a high frequency, phrase-based communication system in an easy to use yet very engaging format. The progressive system offers a variety of topics for everyday needs and conversation and provides AAC users immediate and more successful communication exchanges within a variety of settings.

Spelling

Spelling is a QWERTY keyboard page set with four word prediction buttons and a few pre-stored phrases.

VocabPC

VocabPC was designed by Gail Van Tatenhove, PA, MS, CCC-SLP, for adults and adolescents with developmental disabilities. Vocabulary in VocabPC is arranged as carrier phrases, interactive sentences, activity vocabulary, and naming words. VocabPC uses a 12 location page layout. Both portrait and landscape versions of VocabPC are included.

WordPower20 Simply

WordPower20 Simply incorporates carrier phrases with core words for quick and easy language generation. It can be used as a phrase-based system or as a word-based system. For example, you could use the carrier phrases “I want...”, “I like...”, and “I need...” to generate sentences. Or you could use the individual pronouns “I”, “it”, and “you”, or sentences starters such as “can” and “do.” When the individual pronouns are selected, a page of frequently used verbs and helping verbs also becomes available. You can quickly finish a sentence using a phrase such as “to eat...”, “to play...”, “to watch...”, etc., or you can select “to” and have a more expanded set of verbs available.

WordPower25 Touch & Scan

The WordPower25 Touch & Scan vocabulary is designed to be accessible via direct selection as well as scanning for quick and easy language generation. It incorporates carrier phrases with core words that move seamlessly between the main page and related categories. Individuals who need a sophisticated and efficient language system with a minimum number of cells per page will benefit from this robust vocabulary.

WordPower42

WordPower42 is a word-based vocabulary that allows for easy and intuitive communication. WordPower42 is a generative language system that will be familiar to those using WordPower on other systems, and it is easy to learn for new users.

WordPower42 Basic

WordPower42 Basic is a simplified version of WordPower42. This word-based system remains rich in core vocabulary, and it may be appropriate for beginning users or those who need a more basic vocabulary design. It is designed to make communication fast and easy.

WordPower48

WordPower48 is very similar to the 42-location, but in the extra column on the left, you now have a clear display, delete word, period, and plural. This configuration can be set up for scanning or to be used with a keyguard.

WordPower60

WordPower60 consists of a large number of high-frequency words available on the main page, resulting in fast communication with reduced keystrokes. Word completion and logical next words are used, and the “grammar” function provides morphological endings to verbs, nouns, and adjectives. Spelling with word prediction along with the category-based pages contained in all other versions of the vocabulary are also available. This vocabulary is configured to work with a keyguard.

WordPower60-Basic

WordPower60-Basic was designed with early language learners in mind, providing ample picture support and novel structures to facilitate expressive language development. Core vocabulary is embedded within category and activity pages, allowing easy generation of language from the main core page as well as within specific topic-based pages. Core words remain consistent in terms of placement and access, providing a natural bridge between core and fringe words. Early literacy is enhanced by providing pages designed to teach language and core through children’s books.

WordPower80

WordPower80 is for someone who has good vision, motor skills, and literacy skills. WordPower80 vocabulary pages consist of core vocabulary, spelling, and word prediction.

WordPower108

WordPower108 consists of a large number of high-frequency words on the main page, resulting in fast communication and quick access to core words. Word completion and logical next words are used, and the “grammar” function provides morphological endings to verbs, nouns, and adjectives.

WordPower108 with Keyboard

WordPower108 with Keyboard is a vocabulary consisting of high frequency core words, spelling, and word prediction. With the keyboard on the main page, the communicator moves seamlessly between words and spelling, thus minimizing keystrokes and the need for navigation. Some core words are embedded within the category pages in order to assist in bridging the gap between core and fringe vocabulary.

WordPower140

WordPower140 was designed with switch scanners in mind, although direct selectors with good vision and motor skills are also appropriate. The large number of cells makes communication fast and easy, with less page navigation required. The keyboard and word prediction cells are available on the main page for easy access. Common core words are embedded within the category pages to assist with bridging the gap between core and fringe vocabulary.

Spanish Vocabulary Files

Note: When the system language is set to Spanish, the Spanish vocabulary files will be listed individually when you tap Choose New Vocab and the English vocabulary files will be located in a folder labeled “English”. When the language is set to English, the English vocabulary files will be listed individually when you tap Choose New Vocab and the Spanish vocabulary files will be located in a folder named “español”.

MultiChat 15 Spanish

MultiChat 15 Spanish is the student version developed for devices running TouchChat. This Spanish version is very similar to the English MultiChat 15 Student file. However, due to the differences in the two languages, some changes have been made to accurately represent each language.

MultiChat 15 Spanish Bilingual

This vocabulary file is exactly the same as the MultiChat 15 Spanish file except that the labels on the buttons show both English and Spanish words or phrases. Please note that when the device speaks the words or phrases, they are only spoken in Spanish.

Sin sintaxis 4 x 4 English and Spanish

Sin sintaxis 4 x 4 English and Spanish consists of categories of words with a symbol on each button. This file is intended for children who do not have the ability to construct sentences yet.

Sintaxis 4 x 5 English and Spanish

Sintaxis 4 x 5 English and Spanish is intended for children who are beginning to create simple sentences. Each page contains 20 buttons, and each button contains a word or phrase with a picture. Words are organized into categories with some core words for creating beginning sentences.

Teclado

Teclado is a Spanish keyboard.

VocabPC Spanish

VocabPC Spanish is a direct translation of the English version. VocabPC was designed by Gail Van Tatenhove, PA, MS, CCC-SLP, for adults and adolescents with developmental disabilities. Vocabulary in VocabPC is arranged as carrier phrases, interactive sentences, activity vocabulary, and naming words.

WordPower48 Español

Designed to be intuitive and easy to use, WordPower 48 Español meets the communication needs of a wide group of individuals in Spanish speaking cultures. The vocabulary includes easy to access basic communication for beginning communicators, as well as sophisticated language and grammar for individuals with advanced cognitive and linguistic abilities.

WordPower48 Español Basico

WordPower48 Español Basico was designed with early language learners in mind, providing ample picture support and novel structures to facilitate expressive language development. Core vocabulary is embedded within the category and activity pages, allowing easy generation of language from the main core page as well as within topic-based pages. Core words remain consistent in terms of placement and access, providing a natural bridge between core and fringe words.

WordPower60 Español Básico

WordPower60 Español Básico is comparable in terms of content and design to the English WordPower60 Basic vocabulary. It was designed with early language learners in mind, providing ample picture support and novel structures to facilitate expressive language development. Core vocabulary is embedded within the category and activity pages, allowing easy generation of language from the main core page as well as within topic-based pages. Core words remain consistent in terms of placement and access, providing a natural bridge between core and fringe words. Early literacy is enhanced through the use of pages designed around several popular children’s books. A low-tech communication board is included within the vocabulary file that can be printed as an alternative communication support.





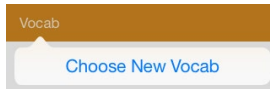

Loading a Vocabulary File

1. Tap **Vocab**. Choose New Vocab will be displayed.





2. Tap **Choose New Vocab**. A page will display a list of the available vocabulary files.

Hint: To make sure that you are working with the latest version of a vocabulary file, view the Modified date and time that appear after the vocabulary name. A checkmark indicates the vocabulary file that was previously selected.

Date and time of last change		Vocabulary file previously selected	
Edit			Menu
Lock	Name / Description	Version	Last Accessed
	4 Basic 4-Basic offers just that, a Basic vocabulary option with 4 buttons per page.	v2.19	
	MC15 Copy <small>Modified January 23, 2018 at 1:32 PM</small>	v1.0	
	mc15 student 2 <small>Modified January 7, 2019 at 3:17 PM</small>	v1.0	✓
	MyCore myCore is a combination of core and phrase based vocabulary geared toward individuals with literacy skills.	v2.19	
	Spelling QWERTY Keyboard layout with Word Prediction	v2.19	
	VocabPC	v2.19	

Hint: You can either scroll down the list to see all available vocabularies or search for a vocabulary. To search for a vocabulary, drag down on the list to reveal the search bar above the list. Tap the search bar to open a keyboard and enter a complete or partial vocabulary name. You can enter any characters from the beginning, middle, or end of a name. Only those vocabulary names that include the characters you enter will be listed. Close the keyboard.

Enter characters from a vocabulary name

Edit			Menu
Lock	Name / Description	Version	Last Accessed
	MC15 Copy <small>Modified January 23, 2018 at 1:32 PM</small>	v1.0	
	mc15 student 2 <small>Modified January 7, 2019 at 3:17 PM</small>	v1.0	✓

3. Select the vocabulary file you want to load.
4. Once loaded, explore the pages and button organization by choosing the buttons. Buttons with arrows will navigate to new pages.

Note: If you plan to customize a vocabulary file, you must first make a copy of it. See “Copying a Vocabulary File”.

Purchasing a New Vocabulary File

To select a new vocabulary that is listed but not available on your device,

1. Scroll through the list of vocabularies to the folder labeled “Available Upgrades”.
2. Click the folder to open a list of vocabularies for which you are not licensed. Each vocabulary will show a shopping cart and a description in grayed-out text.

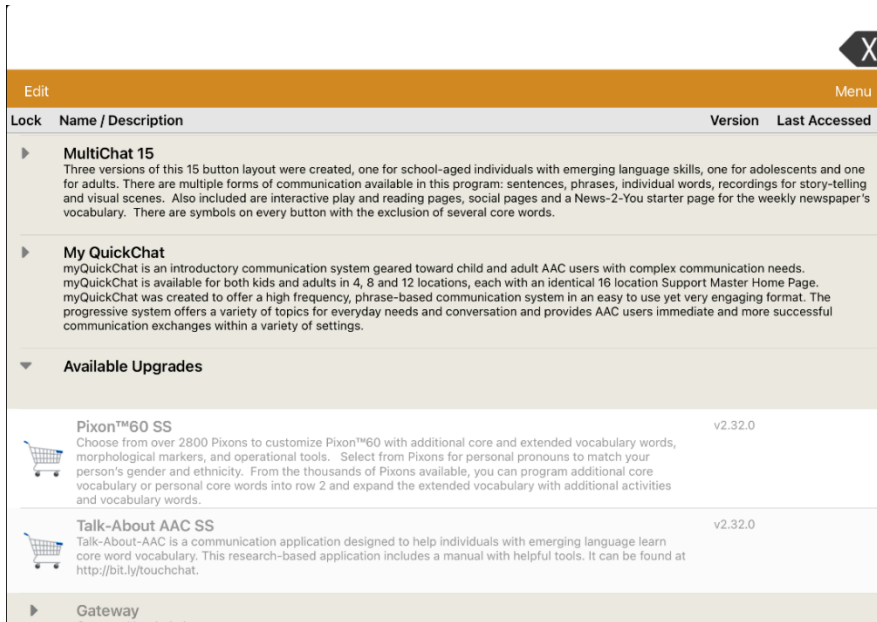

3. When you find the vocabulary you want, select the shopping cart. A message similar to the following will appear.

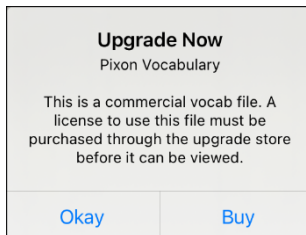

4. To purchase the vocabulary from the Upgrade Store, select **Buy**.

Note: To close the message without buying the vocabulary, select **Okay**.

Copying a Vocabulary File

To customize a vocabulary file, you must first make a copy of the original file. Once you make a copy, you can edit the copy. This keeps the original files in place in case they are needed at a later time.

1. Tap **Vocab** and tap **Choose New Vocab**.
2. Tap **Menu** and tap **Copy a Vocab**. The vocabulary files available on the device are listed by language.
3. Tap the vocabulary file to copy.
4. Give the file a new title and description.
5. Tap **Save**.
6. Tap the new file name to open the file.

Creating a New Blank Vocabulary File

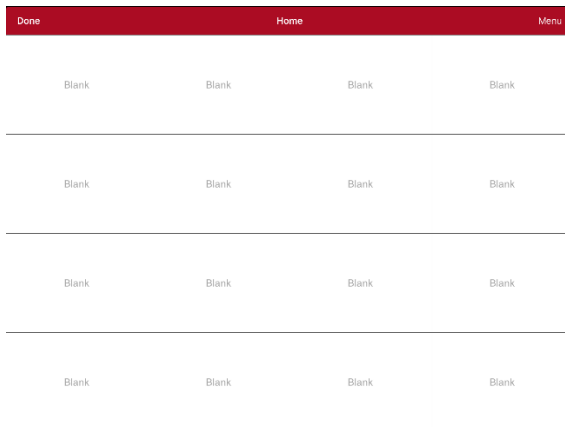

1. Tap **Vocab** and tap **Choose New Vocab**.
2. Tap **Menu** and tap **Create New Vocab**.
3. Give the new vocabulary file a title and description.
4. Tap **Save**.
5. Find the new file you created in the list of available vocabularies and tap the file to open it.
6. Tap **Menu** and tap **Edit Page**. A page of blank locations opens.



7. Tap **Menu** and select **Edit Page Layout**.
8. Set the number of buttons on the page by selecting the number of rows and columns.
9. Tap the first blank location and start creating buttons.
10. When you finish, tap **Done**. You have created the first page of your new vocabulary.

Renaming a Vocabulary File

You can only rename custom vocabulary files.

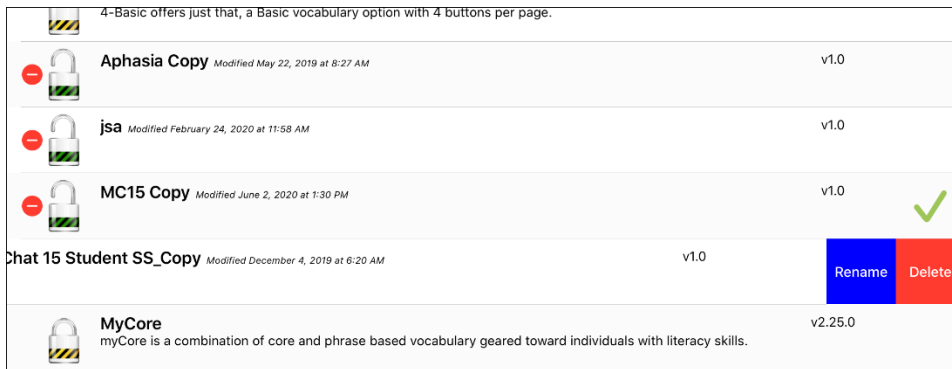

1. Tap **Vocab** and tap **Choose New Vocab**. A page will list the available vocabulary files.
2. Tap **Edit** in the upper left corner of the page. A red icon  will be displayed for each custom vocabulary file.
3. Tap the red icon  next to the file you want to rename. Rename and Delete buttons will appear.



4. Select **Rename**. The Rename window opens.
5. Tap the name field to open a keyboard.
6. Enter the new name, tap **Save**, and tap **Done**.

Deleting a Customized Vocabulary File

You can only delete custom vocabulary files.

1. Tap **Vocab** and tap **Choose New Vocab**. A page will list the available vocabulary files.
2. Tap **Edit** in the upper left corner of the page. A red icon  will be displayed for each custom vocabulary file.
3. Tap the red icon  next to the file you want to delete. Rename and Delete buttons will appear.

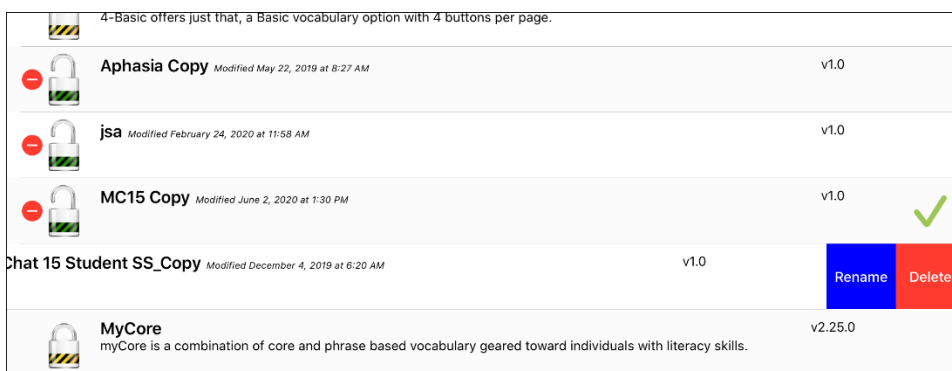

4. Tap **Delete** and tap **Continue** at the Delete Vocabulary message.
*Note: If you did not intend to delete this vocabulary file, tap **Cancel**.*
5. Tap **Done**.

Exporting Vocabulary Files to a USB Drive from Your Device

Important! You can use this procedure only if you have updated your device to iPadOS® 13, iOS® 13, or higher.

1. Plug the USB flash drive into your device.
2. In TouchChat, tap **Vocab** and then tap **Choose New Vocab**.
3. Tap **Menu** and select **Import/Export Vocab**.
4. Tap **Export and Share**.
5. Choose the vocabulary file you want to export.
6. Rename the file if you want and tap **Done**.
7. Tap **Save to Files**.
8. Select the USB drive to export the file to.
9. Tap **Save** at the top right corner. The vocabulary file is now saved to the USB drive.

Importing a Vocabulary File from a USB Drive to Your Device

Important! You can use this procedure only if you have updated your device to iPadOS® 13, iOS® 13, or higher. You can use this procedure when Guided Access is Enabled on your device.

1. Plug the USB flash drive that contains the vocabulary files to import into your device.
2. In TouchChat, tap **Vocab** and then tap **Choose New Vocab**.
3. Choose **Menu** and select **Import/Export Vocab**.
4. Tap **Import from Files**.

Note: A files window will list the vocabulary file you saved to the flash drive. You will only be able to select files that are in .ce, .prt, .wf, or pvf format.*

5. Select the file that you want to import into your device.

Note: The files window will close and the import file information should appear on the Import Vocab screen. The vocabulary name will be displayed.

6. Edit the file information as needed.
7. Tap the **Import** button. The file will be imported into the vocabulary library on the device.

Importing Multiple Vocabulary Files from a USB Drive to Your Device

1. Plug the USB flash drive that contains the vocabulary files to import into your device.
2. In TouchChat, tap **Vocab** and then tap **Choose New Vocab**.
3. Choose **Menu** and select **Import/Export Vocab**.
4. Tap **Import from Files**.

Note: A files window will list the vocabulary files you saved to the flash drive. You will only be able to select files that are in .ce, .prt, .wf, or pvf format.

Important! A **Select** button should be displayed. Alternatively, the **Select** button might be located inside of a menu with an icon which is a circle with three dots. This depends on the device's screen size and orientation.

If multiple importable files are not listed in the location that opens, the **Select** button may not be available at all, even if you navigate to a location that does have multiple files. If this happens, you can first select the location where multiple files are located, then Select Cancel and reopen the import from files window.

5. Tap the **Select** button to start multiple file selection mode.
6. Choose all of the files that you wish to import, or tap the **Select All** button.
7. After selecting files, tap the **Open** button to prepare them for import.

Note: Tapping the Done button will cancel multiple file selection mode.

8. When you tap **Open**, the files window will close and all of the selected files should be listed on the Import Vocab screen.
9. Each file can be selected by tapping it in the list. A checkmark will appear next to the selected file.
10. Edit the file information as needed.
11. Tap the **Import** button. The files will be imported into the vocabulary library on the device.
 - Once a file has been imported, it will be removed from the list of files to import.
 - Files can be removed from the import list by left-swiping on the item.
 - If you tap the Done button, any remaining files that have not been imported will be removed from the list and not imported. The screen will then close.
 - When the last file has been imported, the Import Vocab screen will close automatically.

Choosing a Voice

Because there are many voice options, voices are downloadable. If you only download and install the voices you need, you can save a lot of storage space on your device.

Note: Some voices are only available at a cost. These voices must be purchased from the Upgrade Store before they are available in the Voice list. The Upgrade Store is not available from a TouchChat Lite app.

You can adjust the rate of speech for the voice you select. For some voices, you can also adjust the pitch and add a delay between individual words. To select a voice and adjust speech settings, choose **Menu > Settings**.

Changing the Voice

To change the voice you use to communicate, scroll down to the **Speech** section. The Voice setting displays the voice currently selected.

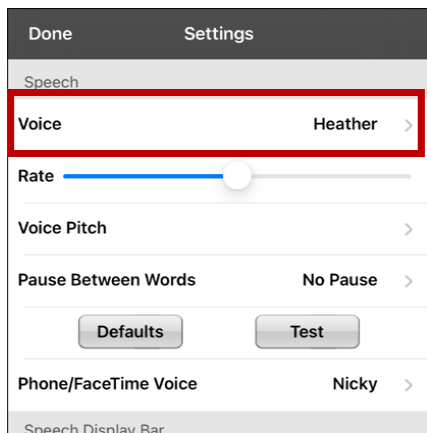

To download and install a different voice, tap **Voice** to open a list of available voices. Voices are listed by language. To add voices in additional languages, see “Adding Voices in Additional Languages” on page 32.

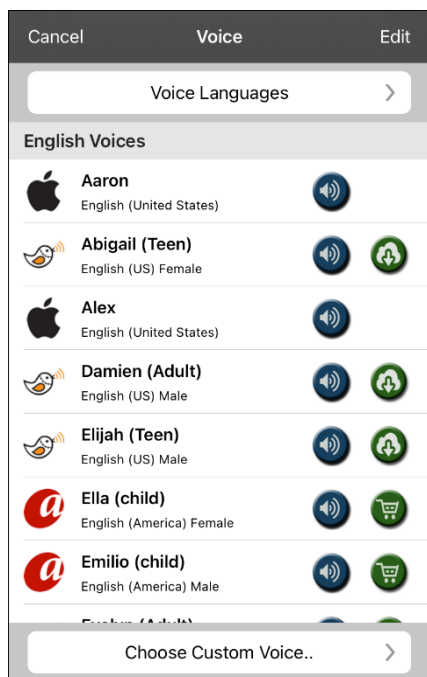

- The voice currently selected displays a checkmark ✓.
- To hear how a voice sounds, select the 🔊 icon. Listen to several voices.
- To purchase a new voice, select the 🛒 icon.
- When you find the voice you want, select the 🔄 icon to download and install it.
- To select a custom voice, tap **Choose Custom Voice** and select a custom voice option. For details, see “Creating Your Voice with Voice Keeper” or “Setting up Your VocaliD™ Voice”.

Adjusting the Voice

Adjusting the Rate of Speech

In the Speech section, use the **Rate** slide bar to modify the rate of speech.

Adjusting the Pitch and Adding a Pause

To adjust the pitch, select **Voice Pitch** and then choose Lowest, Lower, Low, Normal, High, Higher, or Highest. *Note:* This option is not available for all voices.

To add a delay between individual words, select **Pause Between Words** and choose 1 Second, 2 Seconds, or 3 Seconds. If you don't want a delay between words, choose **No Pause**. *Note:* This option is not available for all voices.

Testing Your Speech Settings

To hear how the selected voice sounds at the current settings, select **Test**. If necessary, adjust the speech settings and select **Test** several times.

If you decide to restore all speech settings to their default values and start over, select **Defaults**. A message warns that all speech settings will return to their default values. If you want to restore the default settings, select **Continue**. If you want to keep the current settings, select **Cancel**.

When you finish changing speech settings, choose **Done**.

Adding Voices in Additional Languages

1. Choose **Menu > Settings**.
2. Scroll down to the **Speech** section. The Voice setting displays the voice currently selected.

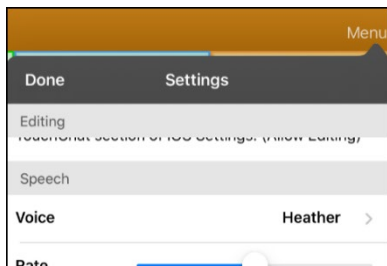

3. Tap **Voice** to open a list of available voices. Voices are listed by language.

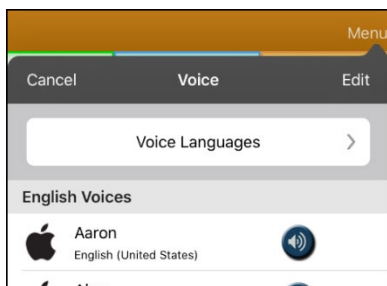

4. Tap **Voice Languages**. The current voice languages are listed.

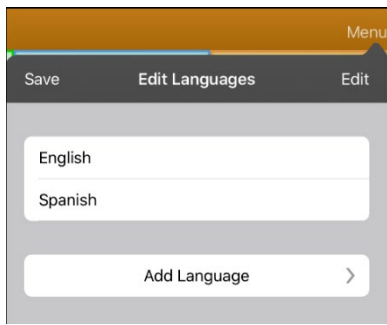

5. Tap **Add Language** to open a list of available voice languages.

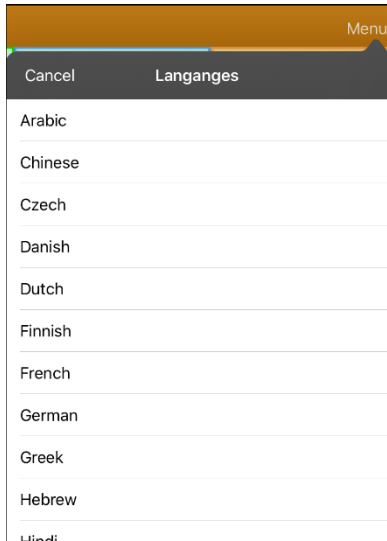

6. Select the language you want. It will be added to the list of available voice languages. For example:

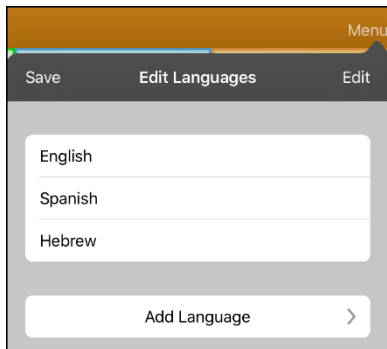

7. Tap **Save**. The list of voices will now include voices available in that language.

Deleting a Voice Language

1. Choose **Menu > Settings**.
2. Scroll down to the **Speech** section. The Voice setting displays the voice currently selected.

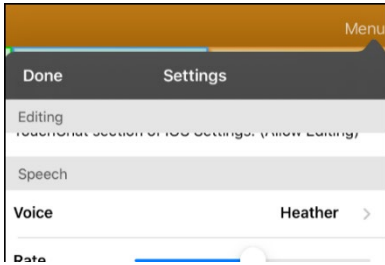

3. Tap **Voice** to open a list of available voices. Voices are listed by language.

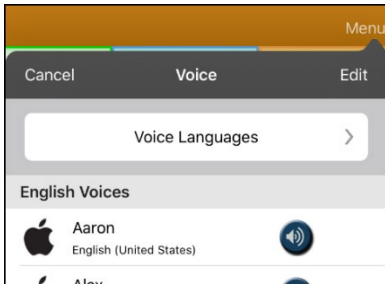

4. Tap **Voice Languages**. The current voice languages are listed. For example:

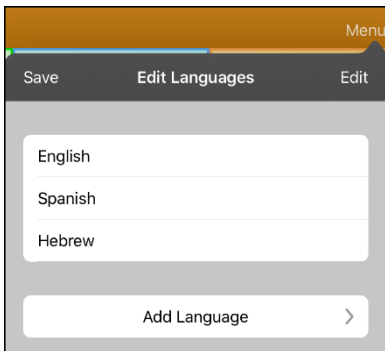

5. Tap **Edit**. Delete icons appear in front of each voice language.

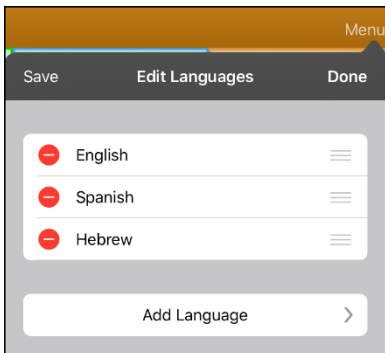

6. Tap the icon for the voice language you want to delete. Delete will appear after the voice language.

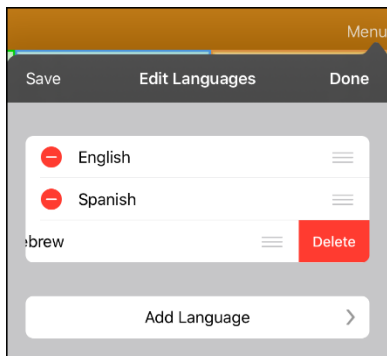

7. Tap **Delete**. The language will be removed from the List.
8. Tap **Save**.

Creating Your Voice with Voice Keeper

1. Enable a Wi-Fi connection.
2. To use the voice with the app, choose **Menu > Settings**.
3. Scroll to the Speech section, tap **Voice**, and tap **Choose Custom Voice**.

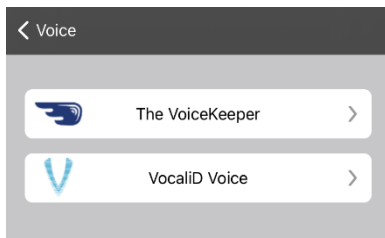

4. Select **The VoiceKeeper**.
5. Select **Create Your Voice Now**.
Note: If you already created a voice, select **Connect to Your Voice** and choose the appropriate voice option. The voice will download automatically and be set as your new voice. Select **Done**.
6. Read the information on the page that opens.
7. Scroll down the page and enter your email address and create and confirm a password.
8. Tap **Create account**.
Note: If you already have an account, tap **Login/existing account**.
9. Follow the instructions on the Voice Keeper website to create your voice. As you record your voice, keep in mind the following tips:
 - Record on a computer with a USB headset/microphone **or** record on an iPhone® using the built-in microphone.
 - Ensure you are recording in a quiet, echo-less room.
 - Although you get a sample of your voice in only 3 minutes (30 sentences), recording 200-300 sentences provides about 80% of optimal quality. The more you record, the better your synthesized voice will be.
 - Speak naturally. Don't try to narrate or emphasize pronunciation. Be yourself when you read.
 - Re-record a sentence if you make a mistake.
10. Try out your voice on the website. If you decide to use it with your PRC-Salttillo app, follow the instructions on the website to deploy the voice to your app.

To use your custom voice:

1. To use the voice with the app, choose **Menu > Settings**, scroll to the Speech section, tap **Voice**, and select **Choose Custom Voice**.
2. Select **The VoiceKeeper**.
3. Select **Connect Your Voice**.

Setting up Your VocaliD™ Voice

1. Enable a Wi-Fi connection.
2. Choose **Menu > Settings**.
3. Scroll to the Speech section, tap **Voice**, and tap **Choose Custom Voice**.

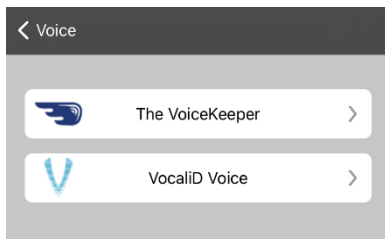

4. Select **VocaliD Voice**. A VocaliD login screen is displayed.

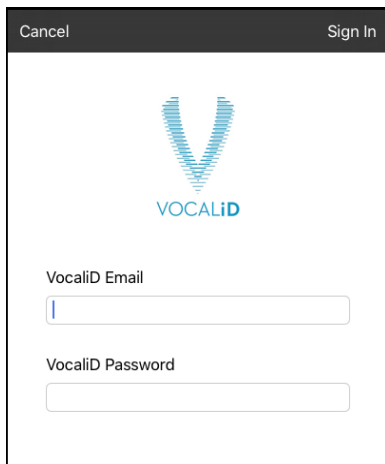

5. Enter your VocaliD email address and VocaliD password.
6. Tap **Sign In** in the upper right corner to display a Download Voice prompt.
7. Tap **Download Voice**. "Downloading Voice" will be displayed.
8. When the download is complete, "New Voice Installed" will be displayed.
9. Tap **Okay**.
10. Tap **Done**. The downloaded VocaliD voice is now your primary voice.
11. Test the voice and adjust the rate and pitch as needed.

Changing How a Word is Pronounced by a Voice

Note: Before changing the pronunciation of a word, be sure that the voice you want to use is selected. Pronunciation lists are unique for each voice synthesizer. For example, Apple voices and Voice Keeper voices have separate pronunciation lists.

1. Tap **Menu** and tap **Edit Pronunciations**.
2. Tap **+**.

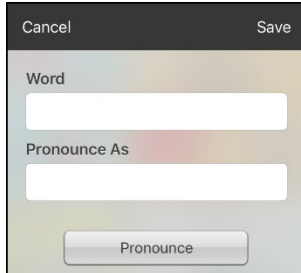

3. In the space under **Word**, type the correct spelling.
4. In the space under **Pronounce As**, type the word phonetically (the way it should be pronounced). Tap **Pronounce** to determine if it is pronounced correctly. If not, change the spelling until the word is pronounced correctly.
5. Tap **Save** and tap **Done**.
 - If the word already exists in the Pronunciation list, scroll up to find the word and then tap the word to edit to the correct pronunciation.
 - For information on changing a pronunciation for a specific button, see “Changing the Pronunciation of a Word in a Button Message”.

Using ChatEditor with TouchChat

ChatEditor™ is a supplemental program that runs on a Microsoft® Windows® desktop or laptop computer. It allows you to customize vocabulary files. Although customizing is also possible on the device itself, the Editor allows the family and/or professionals to customize the vocabulary when the device is not present.

Note: Having the custom vocabulary on a computer is always recommended as a backup to the device. See “Copying a Vocabulary File from the Device to ChatEditor using iTunes” on page 42.

Downloading and Installing ChatEditor

Important! With software release 2.0, we replaced TouchChat Windows Editor with ChatEditor. If you have used TouchChat Windows Editor in the past, it will no longer work with 2.0 files or newer.

The installation process installs ChatEditor on your computer and creates a desktop shortcut to the ChatEditor application.

Hint: To see a video that explains how to download and install ChatEditor, go to

<http://touchchatapp.com/support/videos/touchchat-chat-editor-installation>

To download and install ChatEditor:

1. Go to <http://touchchatapp.com/support/software-updates>
2. Under “ChatEditor for Windows”, select the Download version link.
3. Save the downloaded ChatEditor_x.x.x_Setup.exe file to your desktop.
4. Double-click the ChatEditor_x.x.x_Setup.exe file to start the installation process.
5. Select the language you want to use for the installation and click **OK**.
6. Click **Next**, accept the license agreement, and click **Next**.
7. Click **Install**. When the installation process is complete, click **Finish**. You should see a desktop shortcut to the ChatEditor application.

Configuring ChatEditor

1. Double-click the ChatEditor desktop shortcut to open ChatEditor.
2. Select **TouchChat** from the Choose Product window and click **OK**.
3. Select your language from the Choose Language window and click **OK**.
4. Select one or more symbol sets from the Choose Symbol Sets window.

Important! This symbol set must match what is on the device you are supporting.

5. Click **OK**.
6. Type a descriptive name for the configuration in the Enter Name window and click **OK**.
7. ChatEditor will open.

Note: You may need to set up multiple configurations if you support more than one client. For example: Tommy with only SymbolStix® images and Sarah with both SymbolStix and PCS™ symbols.

Enabling Speech and Symbols in ChatEditor

When you install ChatEditor, messages similar to the following will be displayed:

You must attach a PCS-configured TouchChat Device to enable and display PCS Symbols.
Click OK to continue.

Speech is currently disabled.

Please connect a TouchChat device to this computer to enable speech.

Choose **OK** to close the message.

To enable speech or symbols in ChatEditor, simply connect a USB cable between your computer and your device.

Test the Editor to verify that speech is working or symbols are displaying. Then disconnect the cable. Speech and symbols will now be enabled whenever you use the Editor; you will not need to re-connect the cable.

Opening ChatEditor

To open the Editor for normal use after you have set up a configuration, choose the ChatEditor shortcut from your computer's desktop. The Editor will open on your computer.

Using ChatEditor to Create Instructional Materials

Capture sequences of buttons from screens in ChatEditor to paste into instructional materials you create such as Word documents, PowerPoint presentations, flash cards, etc.

1. In ChatEditor, choose **Capture** in the top section of the Editor window. The Button Capture window will open.
2. With **Capture Selections** selected, start selecting the buttons you want to appear in your document. Each button you select will be captured in the Button Capture window.



3. When you finish capturing a sequence of buttons, choose **Copy to Clipboard**. The sequence will be cleared from the Button Capture window.
4. In your document, insert the cursor and select **Paste**. The sequence will be pasted into the document.
5. Capture the next sequence.
6. When you finish capturing sequences, select **Exit** to close the Button Capture window.

Notes on Capturing Button Sequences

If you need to try several sequences to find the one you want, turn off Capture Selections. Once you decide what you want to capture, turn Capture Selections back on.

If you make a mistake, select **Clear** and start capturing the sequence again. Keep in mind that Clear removes **all** captured content from the Button Capture window.

Transferring a Vocabulary File from ChatEditor to the Device using iTunes

1. Open ChatEditor on your computer.
2. Choose **Library > Transfer > Vocab to File**. The Transfer box will appear.
3. Highlight the file you want to transfer and click **Transfer** in the top left.
4. Save your vocabulary file to your computer (remember where you save it).
5. Connect the device to the computer.
6. Open iTunes on the computer.
7. In iTunes on the computer, click the small device icon in the upper left portion of the window.

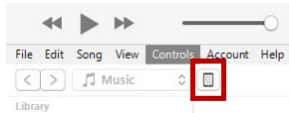

8. In the window that opens, click **File Sharing** on the left.
9. In the Apps column, select the **TouchChat** app. "Add File" should appear in the lower right-hand section.
10. Tap **Add File**. An Add window opens.
11. Locate the file you want to add to your device and tap **Open**.
12. The file should appear in the TouchChat Documents section.
13. In TouchChat on your device, select **Vocab** and **Choose New Vocab**.
14. Select **Menu**, **Import/Export Vocab**, and **Import from iTunes**.
15. Select the file you want to import and select **Save** in the top right portion of the screen. Your imported file should appear in the list of vocabularies.
16. Select the file.

Copying a Vocabulary File from the Device to ChatEditor using iTunes

1. Connect the device to the computer.
2. Open iTunes on the computer.
3. In TouchChat, select **Vocab** and **Choose New Vocab**.
4. Select **Menu**, **Import/Export Vocab**, and **Export to iTunes**.
5. From the menu that opens, select the vocabulary file you want to export and select **Save**.
6. In iTunes on the computer, click the small device icon in the upper left portion of the window.

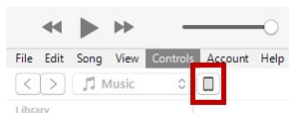

7. In the window that opens, click **File Sharing** on the left.
8. In the Apps column, select the **TouchChat** app.
9. From the column under **TouchChat Documents**, select the vocabulary file you are exporting.
10. Click **Save** on the bottom right. A Save window will open.
11. Navigate to the folder in which you want to save the file and click **Select Folder**.
12. Click **Done** and exit from iTunes.

Activating Edit Mode

You can only edit a copy of a vocabulary file, not the original. To make a copy, see “Copying a Vocabulary File” on page 27.

1. Go to the page you want to edit.
2. Tap **Menu**.
3. Tap **Edit Page**. The page is now in Edit Mode.

Working with Buttons

What a button speaks, how it appears, what icon is shown, what action the button performs, and the location of a button can be modified. All button modifications are performed in Edit Mode.

Editing a Button

1. Go to the page you want to edit and tap **Menu**.
2. Tap **Edit Page**. The page is now in Edit Mode.
3. Tap the button you want to modify. The Edit Button menu opens.

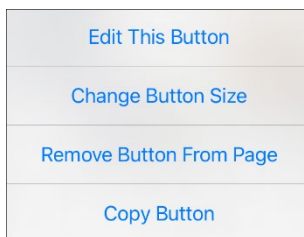

4. Tap **Edit This Button**. A window opens that will allow you to modify the button.
5. Tap the menu option or options you want to use.
6. Tap **Save** to save your changes.
7. Tap **Done** to exit Edit Mode.

Changing a Button Label or Message

1. Tap **Menu** and tap **Edit Page**.
2. Tap the button you want to modify.
3. Tap **Edit This Button**.
4. Tap in the Button Label area to change the label that will be displayed on the button.
5. Tap in the Button Message area to change the message that will be spoken.
6. Select **Save** and **Done**.

Changing the Pronunciation of a Word in a Button Message

1. Navigate to the page that contains the button you want to edit.
2. Tap **Menu** and select **Edit Page**.
3. Tap the button and select **Edit This Button**. The Edit Button window opens.



4. Tap in the box below **Alternate Pronunciation**. A keyboard opens.
5. Enter the pronunciation you want.
6. Tap the speaker icon  to hear how the pronunciation you entered sounds.
7. Modify the pronunciation as often as necessary until the word is pronounced the way you want it.
8. Tap **Save**. To save the pronunciation.
9. Tap **Done** to exit edit mode.
10. When you choose the button to add it to the SDB, the word will be spoken using the pronunciation you entered.
 - If you later edit the button and change the message, the SDB will no longer speak the alternate pronunciation.
 - If a button appears in multiple locations, each can have its own alternate pronunciation.
 - For information on changing a pronunciation for a specific voice synthesizer, see “Changing How a Word is Pronounced by a Voice”.

Adding or Changing a Button Action

To add a button action:

1. Tap **Menu**, tap **Edit Page**, tap the button you want to modify, and tap **Edit This Button**.
2. Scroll down to the Button Actions section.
3. Tap **Add**.
4. Scroll through the list of actions and tap the action you want. It will be added below the existing action for the button.
5. Tap **Save** and **Done**.



To change a button action:

1. Tap **Menu**, tap **Edit Page**, tap the button you want to modify, and tap **Edit This Button**.
2. Scroll down to the Button Actions section.
3. Tap the existing action. The list of available actions will be displayed, with the existing action selected.
4. Tap the new action you want. The new action will replace the old action under Button Actions.
5. Tap **Save** and **Done**.

Removing or Changing the Order of an Action

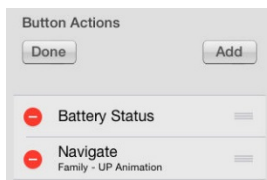
1. While in the Button Actions area, tap **Edit**. The delete icon  will appear in front of each action linked to the button.



2. To remove an action, tap the delete icon  and then tap **Delete**. To rearrange the order of the actions, touch and hold the gray bars  to the right of an action and drag the action into the correct position.
3. Tap **Done**.
4. Tap **Save** and **Done**.

Available Button Actions

Action	Description
Add Message to Display	Inserts text from the button's Message box in the Speech Display Bar (SDB), but the words are not spoken
Add Time/Date	Displays the current date and time in the SDB
Apply Grammar Property	Identifies a word as an adjective, noun, or verb
Apply Grammar State	Applies a grammar rule to a word
Apply Modifier	Applies the modifier that you selected to another button. A modifier is a special key on a keyboard that modifies the normal action of another key. (Caps Lock, Ctrl, Functions, Num Lock, Shift)
Backspace Key	Deletes the last character in the SDB
Battery Status	Displays the current battery status in the SDB
Calculator	Opens a pop-up window with a functioning calculator
Cancel Visit	Clears all remaining visits
Center Head Tracking	Centers the cursor in respect to the user's current head position
Clear All Modifiers	Releases any Shift, Caps, Ctrl, or Num Lock modifiers
Clear Display	Clears the text from the SDB
Clear Grammar State	Clears a grammar rule that has not been applied to a word
Clear Last Word	Deletes the last word from the SDB
Data Logging On/Off	Toggles data logging on and off. Data logging allows your device to collect language usage data that you can upload to the Realize Language website for web-based analysis or save to a file to analyze manually.
Grammar Action	Changes the existing word to the chosen grammatical form, add –ed, add –en, add –er, add –est, add –ing, Add –s
Help Signal	Triggers a loud attention-getting sound
Jump to Page	Takes you to a new page for a single hit and then takes you back and does not remember any unused visits.
Navigate	Takes you to a pre-defined page
Navigate Back	Takes you to the previous page
Navigate to Home	Takes you to the home page of the vocabulary file
Open App	Opens a specific iPad app from a vocabulary page. <i>Not available on a dedicated device.</i>
Pause/Resume Speech	Pauses any speech that is currently playing—for example, a speech message or a recorded speech. Activating this action again will resume the paused speech.
Play Library Audio	Plays an audio file from the user's media library. <i>Not available on a dedicated device.</i>
Play Recorded Speech	Plays recordings of someone speaking.
Play Video	Plays a video file from the user's Photo Roll. <i>This file must be stored on the device.</i>

Action	Description
Record Speech	Records someone speaking.
Repeat Last Spoken	Repeats the last spoken message
Select Profile	Changes Settings to match the saved set of settings, saved as a profile
Speak	Pronounces the text in the SDB
Speak Label Only	Speaks the button label, but does not display it in the SDB
Speak Last Sentence	Speaks only the last sentence in the SDB
Speak Last Word	Speaks only the last word in the SDB
Speak Message Only	Speaks the button message, but does not display it in the SDB
Speech Message	Speaks the button message and displays it in the SDB
Static Char Prediction	Displays the most probable character in compliance with the current character displayed in the SDB, the selected prediction order, and the static character list used by the dictionary. Sets the prediction order (1-10) for character prediction buttons on a keyboard page.
Static Word Prediction	Displays the most probable word in compliance with the current characters displayed in the SDB, the selected prediction order, and the static word list used by the dictionary. Sets the prediction order (1-10) for word prediction buttons on a keyboard page.
Stop Library Audio	Stops audio and video files from the user's library. <i>Not available on a dedicated device.</i>
Stop Scan	Stops a scan that is in progress
Stop Speech	Stops the speech file currently playing.
Store Text to Button	Stores text currently displayed in the SDB to the button you select
System Keyboard	Opens the iPad keyboard
Take a Photo	Activates the device camera so you can take pictures that will appear on a button and will also be saved with other images on the device.
Text Copy	Copies the text in the SDB to the system clipboard. The copied text can then be pasted into other apps. <i>Not available on a dedicated device.</i>
Text Paste	Pastes the text from the system clipboard into the SDB. This allows text from other apps to be pasted into the TouchChat app. <i>Not available on a dedicated device.</i>
Text Share	Shares the text in the SDB using email, SMS text, the social network services Facebook and Twitter, or the blogging service Tumblr. <i>Not available on a dedicated device.</i>
Texting - Navigate to Conversations	Allows to you add a texting button to a customized vocabulary. Use the button to open your texting app.
Toggle Mute/Unmute	If the device is currently speaking a long message, selecting this button will not stop the speech but stop the speech from being spoken aloud. Selecting the same button again lets the text be heard.

Action	Description
Visit	Takes you temporarily to a previously predefined page and activates a different operational mode—visit mode. Visit mode records the pages and their sequence of loading. Termination of Visit mode is caused by activation of a different type of button and returns the user to the initial page.
Visit Exception	If you have one button on a Visit page that you don't want to return to the previous page, use a Visit Exception action to leave it on the page for one additional hit.
Volume Down	Turns the volume down
Volume Up	Turns the volume up
Webhook	Adds a webhook action to a button
Whiteboard	Turns a button into a free-format drawing surface. Select the pen color and width, erase or undo while drawing, and load drawings and save them by name.
Word Finder	Finds the path to a word you are looking for. This action opens a Word Finder window. Enter a word and select Find . One or more paths to the word are displayed. Select a path and follow it to the word.

Inserting Special Characters

Sometimes you may need to insert a special character in a word that you type, such as a letter with an accent; for example, **ó**.

On the keyboard, press and hold the applicable character key. A small menu of special characters available for that character will open above the key. Select the special character you want.

For example, to insert the special character **ó**, you would hold down the “**o**” key on the keyboard and select **ó** from the small menu.

Adding an Image to a Button: Enter a Label and Browse

1. Tap **Menu** and select **Edit Page**.
2. Tap the button and select **Edit This Button**.
3. Enter a label and message for the button.



4. Tap the small arrow that appears to the right of the image area. An image related to your label will be displayed with arrows on the left and right.
5. Use the arrows to scroll through available images.
6. When you find the image you want, tap **Save**.
7. Tap **Done** to exit edit mode.

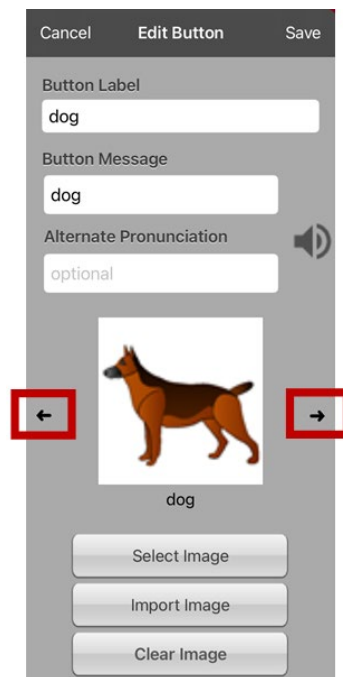

Adding an Image to a Button: Search

1. Tap **Menu** and select **Edit Page**.
2. Tap the button and select **Edit This Button**.
3. Tap **Select Image**.
4. Tap the magnifying glass icon at the top right.

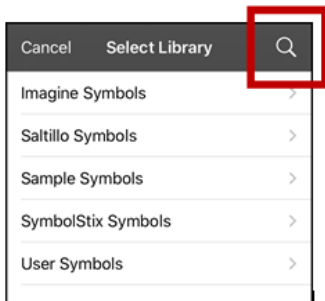

5. Enter an image name or description.
6. Tap **Search** on the keyboard. Image names will be listed with preview images.
7. Select the image you want.
8. Tap **Save**. Tap **Done** to exit edit mode.

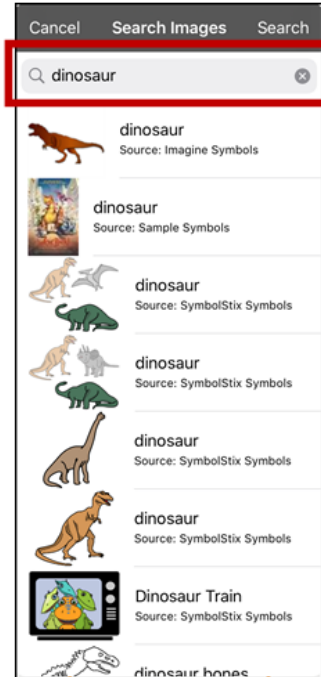

Adding an Image to a Button: Select Categories

1. Tap **Menu** and select **Edit Page**.
2. Tap the button and select **Edit This Button**.
3. Tap **Select Image**.
4. Tap an image category and subcategory (when available).

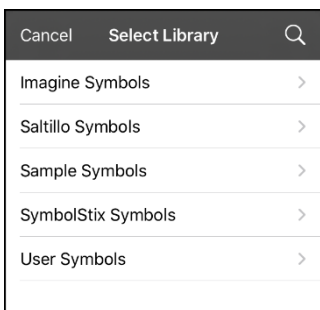

5. Image names will be listed with preview images.
6. Scroll through the images and select the one you want.
7. Tap **Save**. Tap **Done** to exit edit mode.

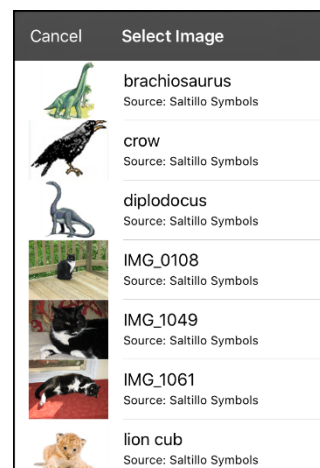

Adding an Image to a Button: Import

This option provides access to pictures that have already been taken and saved on the device.

1. Tap **Menu** and select **Edit Page**.
2. Tap the button and select **Edit This Button**.
3. Tap **Import Image**. A small menu will open.

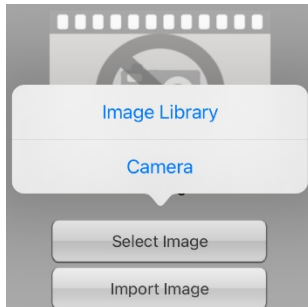

4. Tap **Image Library**. Collections of images will be listed.
5. Tap a collection. Preview images will be displayed.
6. Tap the image you want and tap **Use**.



7. Enter a name for the image and tap **Done**.
8. Tap **Save**. Tap **Done** to exit edit mode.

Adding an Image to a Button: Take a Picture

1. Tap **Menu** and select **Edit Page**.
2. Tap the button and select **Edit This Button**.
3. Tap **Import Image**. A small menu will open.

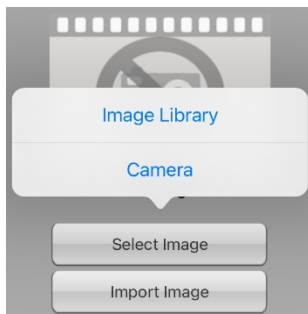

4. Tap **Camera**.
5. Press the camera button.



6. Tap **Use Photo** and enter a name for the image.
7. Tap **Done** and tap **Save**. Tap **Done** to exit edit mode.

Changing the Skin Tone of People on Buttons in a Vocabulary

Note: This feature applies to SymbolStix images only.

Use the Skin Tone feature to change the skin tone of people displayed on buttons in a vocabulary.

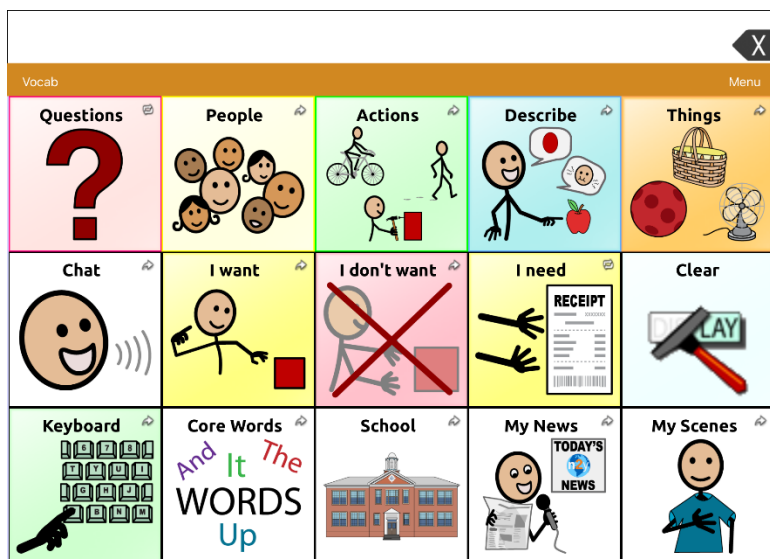

1. Choose **Menu > Settings**, scroll to the **Buttons** section, and select **SymbolStix Skin Tone**.
2. A choice of skin tones will be displayed. A checkmark indicates the current selection.

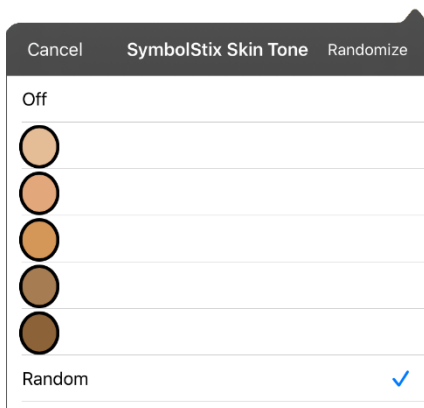

- When **Off** is selected, images of people show their default skin tones.
- When one of the five specific skin tones is selected, all images of people will show that skin tone.
- When **Random** is selected, images of people will randomly show those five skin tones throughout the vocabulary file.

3. Select the skin tone option you want. Your selection will appear after the “SymbolStix Skin Tone” setting. For example:

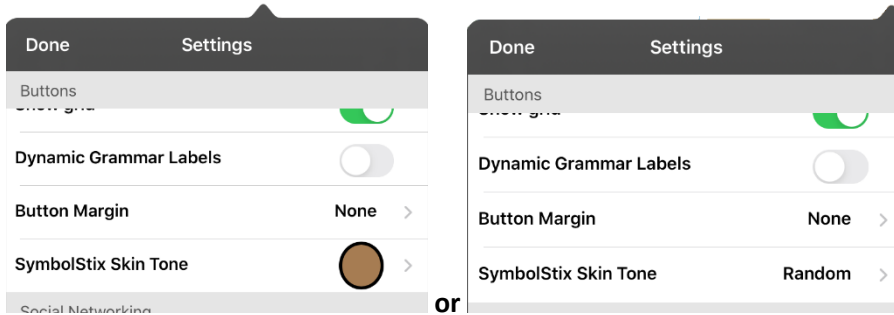

4. Select **Done**. As you navigate through your vocabulary, images of people will display the skin tone you selected or random skin tones.

If you selected one of the five specific skin tones, all images of people will show that skin tone.

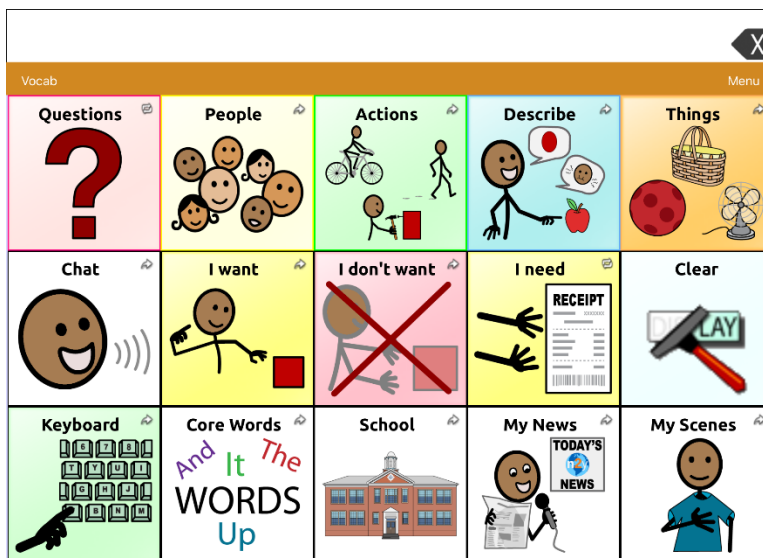

If you selected **Random**, images of people randomly show the five skin tones.

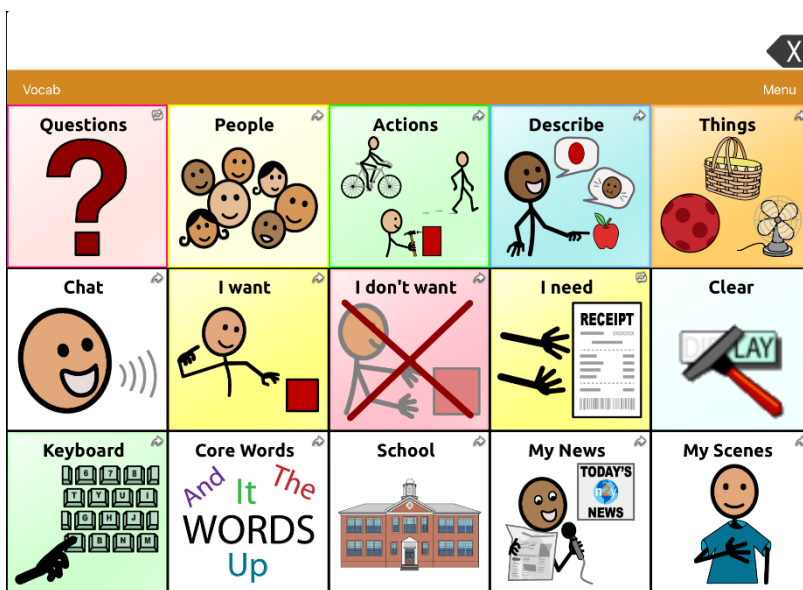

Changing the Skin Tone of People on a Specific Button

1. Navigate to the page that contains the button you want to edit.
2. Tap **Menu** and select **Edit Page**.
3. Tap the button and select **Edit This Button**. The Edit Button window displays the image of the person on the button.



Note: The Skin Tone button only appears with buttons that display certain SymbolStix images of people.

4. Choose the **Skin Tone** button. A choice of skin tones will be displayed. A checkmark indicates the current selection.

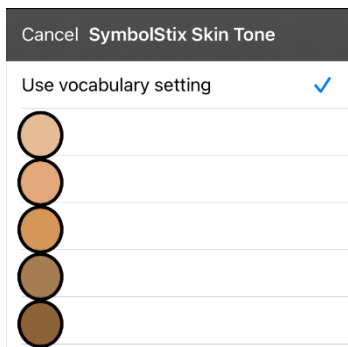

5. Select the skin tone you want to apply to the button.

6. Select **Save** to save the skin tone and select **Done** to exit edit mode. The image of the person on the button will display the skin tone you selected.

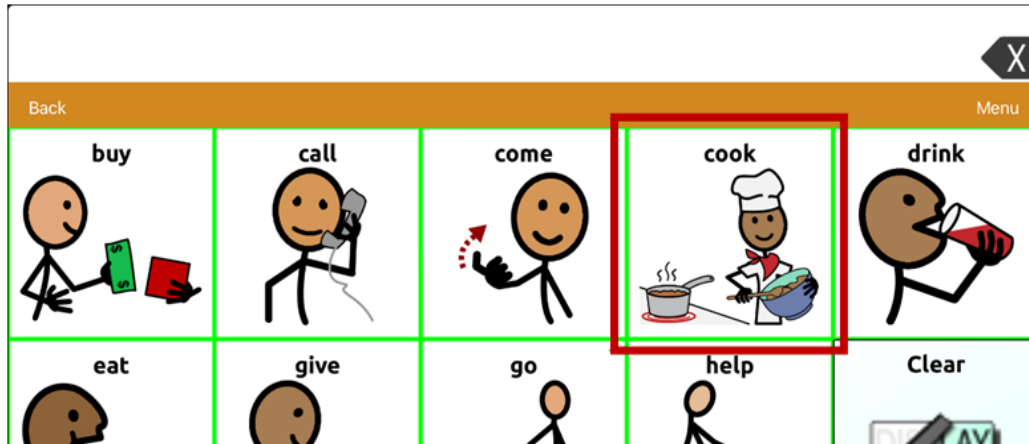

- If a skin tone is set in the vocabulary, the button setting overrides it.
- If you later replace the image with something other than a SymbolStix image of a person, the skin tone you selected will not be used.
- If you copy and paste the button style, the new skin tone will not be included.

Creating a Camera Button

Note: This feature provides an alternative so you don't need to enter Edit Mode to add a picture to a button.

You can create a button that allows you to take a picture that will be imported to the button automatically every time you tap the button. The picture will also be added to your library of imported images. Each time you press the button, a new image from the camera will replace the existing image on the button. If the old image on the button was imported and not used elsewhere, it will be deleted. An image will appear on the button until you press the button again.

To set up the button action:

1. Go to the page with the button location you want.
2. Tap **Menu** and select **Edit Page**.
3. Tap the button you want to use.
4. Select **Edit This Button**.
5. Add a label and message.
6. Scroll down to "Button Actions" and tap **Add** to open the list of actions.
7. Scroll down the list and tap **Take a Photo**.
8. The Take a Photo action will be added to the button's actions.
9. Tap **Save**. Tap **Done** to exit edit mode.

To take a photo for your button:

1. Tap the new button to activate the camera.
2. Press the camera button.
3. Tap **Use Photo**.
4. The photo will appear as the image on the button.

Note: Each time you press the button, a new image from the camera will replace the existing image on the button.

To delete photos:

To delete photos, you must connect your device to your computer and remove the photos using Explorer from the computer.

Resizing a Button

1. Tap **Menu** and select **Edit Page**.
2. Tap the button you want to resize and select **Change Button Size**.
3. Select the number of rows and columns you want.
4. Tap **Save**.

Changing a Button Style

1. Tap **Menu** and select **Edit Page**.
2. Tap the button you want to modify and select **Edit This Button**.
3. Scroll down to the area you want to edit.
4. Edit the font, font size, text color, body color, border color, and/or border width as needed.
5. Tap **Save**.

Changing a Button's Basic Colors

1. Tap **Menu** and select **Edit Page**.
2. Tap the button you want to modify and select **Edit This Button**.
3. Scroll down to the color settings and select **Text Color**, **Body Color**, or **Border Color**.
4. The Select Color window opens to the Default tab.

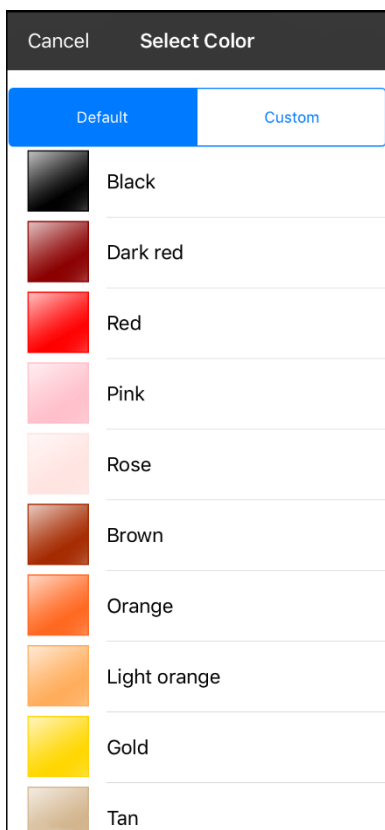

5. Select the color you want and tap **Save**.

Customizing a Button's Colors

1. Tap **Menu** and select **Edit Page**.
2. Tap the button you want to modify and select **Edit This Button**.
3. Scroll down to the color settings and select **Text Color**, **Body Color**, or **Border Color**.
4. The Select Color window opens to the Default tab.
5. Select the **Custom** tab.

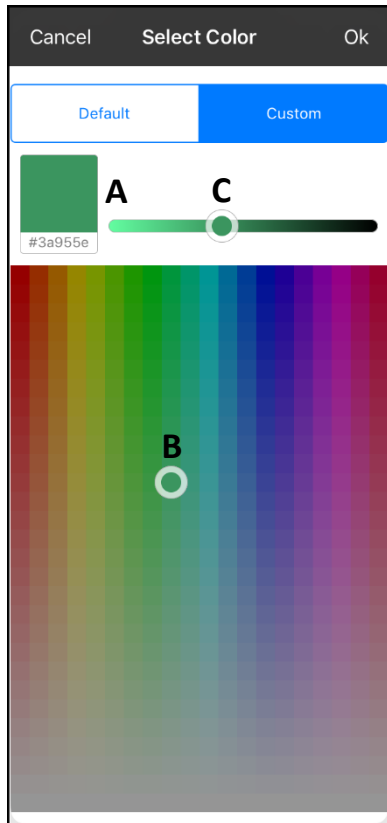

A. If you know the hex code for the color you want:

Tap the hex code at the bottom of the preview box. When a keyboard opens, enter the hex code. The preview box will show the color. Close the keyboard.

B. To create a custom color using the color selector:

Tap in the color gradient. The cursor will move to the spot you tapped, and the preview box will show the current color and its hex code. If necessary, tap different areas until the color you want is shown.

Hint: You can also drag the cursor to areas of the color gradient.

C. To adjust the color:

Tap the color gradient slide bar. The slider will move to that spot and the preview box will show the current color and hex code. Tap different spots along the slide bar until the color you want is shown.

Hint: You can also drag the slider along the slide bar. Release the slider when the color you want is shown.

6. When the preview box shows the color you want, select **OK**.
7. In the Edit Button window, select **Save**.

Creating a Button to Link to a Page

When a button action is set to Navigate or Visit you can determine what page that button will take you to. Navigate will take you to a New Page and leave you there requiring an additional button to be hit to return to your previous page or to the home page. Visit will take you there for one selection and immediately return to the previous page. The following linking button actions are available.

Action	Description
Navigate	Links to a new page and requires another button press to move away from this page
Visit	Links to a page for a single hit and then automatically goes back to the previous page
Jump to Page	Jump to Page takes you to a new page for a single hit and then takes you back to the page that has the jump to page button.
Navigate Back	Returns to the previous page
Navigate to Home	Links to the Home page of the vocabulary file

To create a linking button:

1. Turn Edit Mode on.
2. Tap the button to be linked to the next page.
3. Tap **Edit This Button**.
4. Enter the label and message. (Entering a symbol is optional.)
5. Under the Button Actions, tap **Add**.
6. Select a navigation action for the button from the drop-down list (Navigate, Visit, Navigate Back, Navigate to Home). Navigate and Visit offer a listing of pages to link to. If you choose Navigate Back or Navigate to Home, skip to step 8.
7. Choose the page to navigate to or visit from the listing. If the page does not already exist, choose + and create a new page to link the button to.
8. Tap an animation (how the page will appear as it navigates), or tap No Animation.
9. Tap **Save**.

Note: There may have been a previous action on this button. To remove that action, tap **Edit**, tap the delete icon , tap **Delete**, and tap **Done**.

Storing Text on a Button

1. Go to the page that includes the button on which you want to store text.
2. Tap **Menu** and then tap **Edit Page**.
3. Tap the button on which you want to store text.
4. Tap Edit This Button.
5. Name the button, and optionally create a message and modify the style.
6. Scroll down to the Button Actions section and tap **Add**.
7. Scroll down and tap **Store Text to Button**. The action will be displayed in the Button Actions section.
8. Tap **Save** and then tap **Done**.

Note: Once a sentence or phrase has been constructed, it can now be saved on a button by navigating to the location of the Store Text button that you created. Tap the button, tap **Continue**, and tap the button in which you want to store the text. The text will appear in the button you selected, and each time you tap that button it will speak that saved text.

Creating a Volume Control Button



Excessive volume or sound pressure level when using earphones or headphones can cause hearing loss over extended periods of time.

You can add volume controls to buttons within vocabulary pages.

1. Go to the page on which you want to create the button.
2. In TouchChat, tap **Menu > Edit Page**.
3. Press and hold on the button you want to use. A list of button options appears.
4. Choose Edit This Button.
5. Add a button label and icon.
6. Under Button Actions, choose **Add**. A list of actions appears.
7. Choose either Volume Up or Volume Down.
8. Choose **Save**.

Creating a Battery Status Button

You can create a button that displays the battery status of both the device and the amplifier in the Speech Display Bar (SDB).

1. Go to the page on which you want to create the button.
2. In TouchChat, tap **Menu > Edit Page**.
3. Press and hold on the button you want to use. A list of button options appears.
4. Choose Edit This Button.
5. Add a button label and icon.
6. Under Button Actions, choose **Add**. A list of actions appears.
7. Choose Battery Status.
8. Choose **Save**.

Note: To view the status of the amplifier battery, you must have ChatWrap Connect installed. If ChatWrap Connect is not installed, refer to page 2 of *Installing and Setting up TouchChat on an iOS Device*, which was included in your TouchChat Express package.

Creating a Button to Show the Date and/or Time

You can create a button that will show the date, time, or both in the Speech Display Bar (SDB).

1. Go to the page on which you want to create the button.
2. In TouchChat, tap **Menu > Edit Page**.
3. Press and hold on the button you want to use. A list of button options appears.
4. Choose **Edit This Button**.
5. Add a button label and icon.
6. Under Button Actions, choose **Add**. A list of actions appears.
7. Choose **Add Time/Date**.
8. Choose one of the options: **Date and Time**, **Date Only**, or **Time Only**.
9. Choose **Save**.

Copying and Pasting a Button

You can copy and paste buttons to new locations. If you modify a copy of a button, you will edit only the copy.

1. Tap **Menu** and tap **Edit Page**.
2. Tap the button you would like to copy. The Edit Button menu opens.

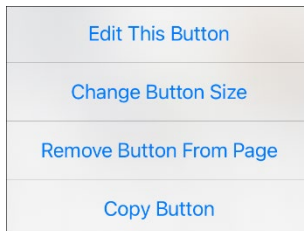

3. Tap **Copy Button**.
4. Tap **Done**.
5. Go to the page where you want to add the copied button.
6. Tap **Menu** and tap **Edit Page**.
7. Tap the location you wish to copy the button to. The Edit Button menu opens with additional options.

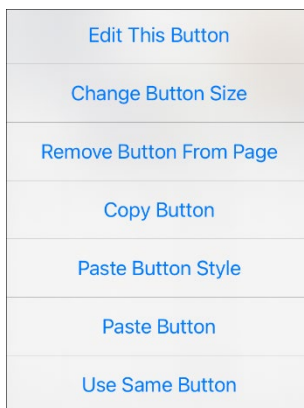

8. Tap **Paste Button**. The button you copied will appear in that location.
9. Tap **Done**.

Copying and Pasting the Same Button

If you modify a button that is used in multiple locations, the button will also be modified automatically everywhere else it appears. You may want to use this technique on buttons that contain tools used on each page.

1. Tap **Menu** and tap **Edit Page**.
2. Tap the button you would like to copy. The Edit Button menu opens.
3. Tap Copy Button.
4. Tap **Done**.
5. Go to the page where you want to add the copied button.
6. Tap **Menu** and tap **Edit Page**.
7. Tap the location you wish to copy the button to. The Edit Button menu opens with additional options.
8. Tap **Use Same Button**. The button you copied will appear in that location.
9. Tap **Done**.

Copying and Pasting a Button Style

“Button Style” refers to the background color and the font size and options that are associated with a button. There are times when it might be faster to copy and paste a button’s style from an existing button rather than editing each of these items on a new button.

1. Tap **Menu** and tap **Edit Page**.
2. Tap the button whose style you want to copy. The Edit Button menu opens.
3. Tap Copy Button.
4. Tap the button you want to paste the style to. The Edit Button menu opens with additional options.
5. Tap **Paste Button Style**. The button will display the pasted style.
6. Tap **Done**.

Moving a Button

1. Tap **Menu** and tap **Edit Page**.
2. Touch the button you want to move and drag it to another location.

Note: When you start to drag the button, the original location will be outlined in red. As you move into the new location, the red outline will move to that location.

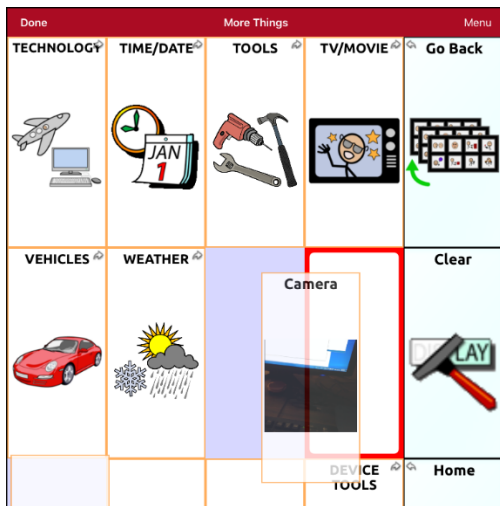

3. Upon release, the button will move to the new location. If there is already a button in the new location, it will move to the old location. The buttons will exchange locations.

Hiding Multiple Buttons at Once

There are times when presenting all buttons at once might be intimidating, or in order to complete a task a button or button set might need to be hidden. Hide Mode hides or redisplay all buttons and button sets. When you hide a button set, all buttons in that location on that page are hidden.

1. Tap **Menu** and tap **Edit Page**.
2. Tap **Menu** and tap **Hide Mode**.

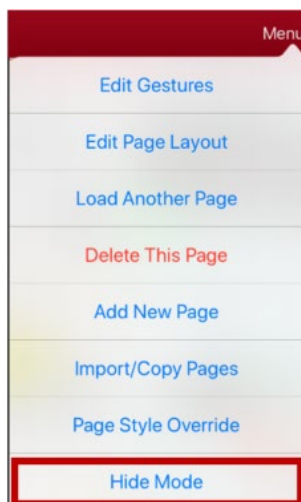

3. Tap the buttons and/or button sets you want to hide.
4. Choose **Done**. The buttons and/or button sets will be hidden. When you tap on a hidden area, it should not activate.

Note: To redisplay a button or a button set, tap **Menu**, tap **Hide Mode**, tap a hidden button or hidden button set, and choose **Done**.

Hiding a Button

1. Tap **Menu** and tap **Edit Page**.
2. Tap the button you want to hide and tap **Edit This Button**.

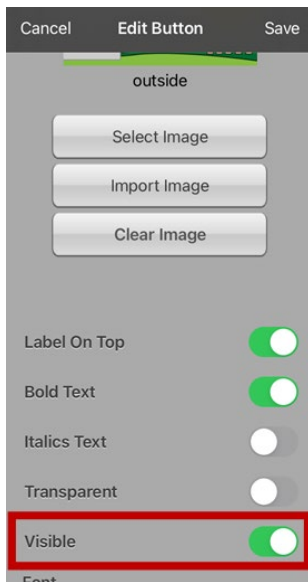

3. Turn **Visible** off.
4. Tap **Save** and **Done**.

Changing Button Timing

Tap **Menu** and tap **Settings**. Scroll down to the “Buttons” section.

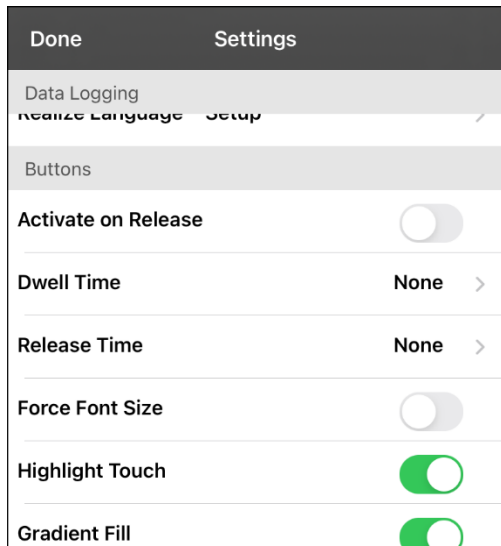

Activate on Release

When this setting is turned on, buttons are activated when released rather than when touched. This allows the device user to slide his or her finger across the screen before finally releasing on the button that he or she wants to select. To turn the setting on or off, tap the Activate on Release toggle switch.

Dwell Time

The dwell time setting controls the delay before a button press is recognized. When the user touches a button, a slight dimming and a white square box identifies the chosen button. As long as the user continues to keep his or her finger inside the button area the dwell timer counts down. Once the time is reached, the button press is accepted. To set a dwell time, tap **Dwell Time** and select a value from 0.1 Seconds to 5.0 Seconds.

Release Time

Release time applies to buttons and to the SDB.

Buttons: Release time is intended to help prevent accidental double button activations. When the time is set, all buttons are disabled for the specified period of time after a button is activated.

SDB: Release time is intended to prevent accidental speaking of words displayed in the SDB twice. When the time is set, the SDB is disabled for the specified period of time after the user taps the SDB to speak the words displayed. The Release Time setting does not affect the SDB Clear button (X).

To set a release time, tap **Release Time** and select a value from 0.1 Seconds to 5.0 Seconds.

Hiding and Showing Button Navigation Arrows

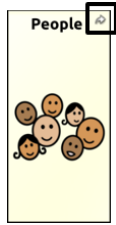

Buttons that navigate to new pages display a small arrow in the top right corner.

To hide or show all navigation arrows:

1. Choose **Menu > Settings**.
2. Under Navigation, tap **Button Navigation Icons**.

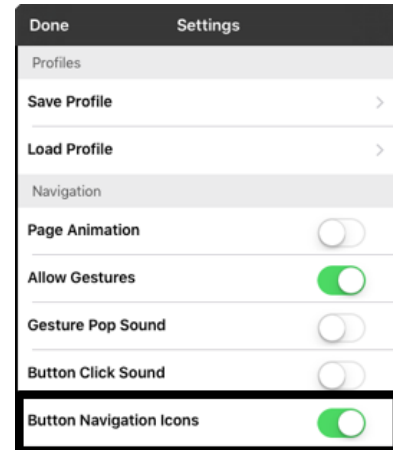

Adding Extra Space around Buttons

1. Select **Menu > Settings**.
2. Scroll to the Buttons section.
3. Select **Button Margin**.
4. Select a margin size. The default size is None. To increase the margin, select an option between 1 Point and 100 Point.
5. When you make a selection, the space between buttons changes.

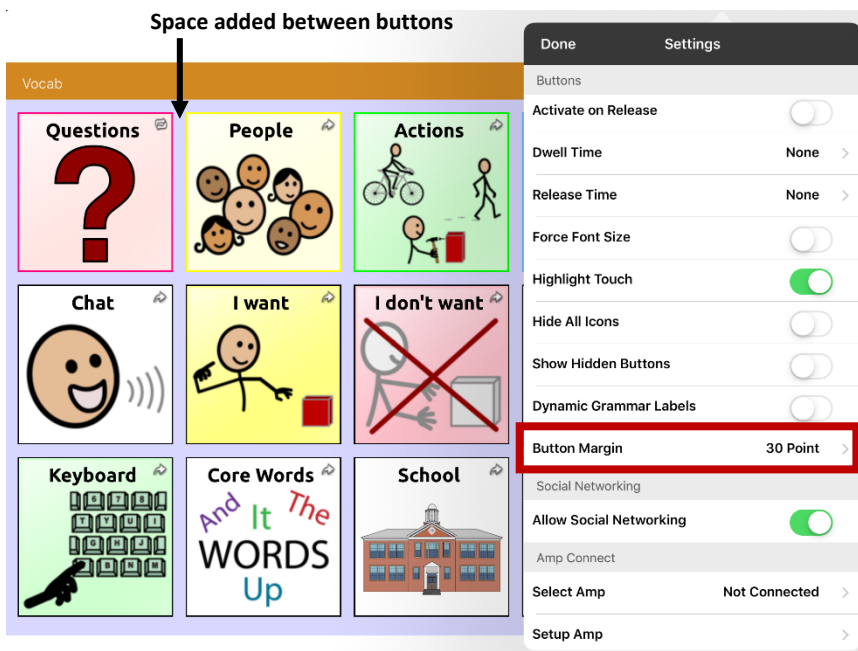

6. If you selected too much space or too little space make another selection.
7. When you are satisfied with the amount of space, select **Done**.

Working with Pages

TouchChat allows you to rename, duplicate, load, and create pages, choose a different keyboard, copy a page from a different vocabulary, add gestures to pages, change the background color of a page, and use special pages.

Renaming a Page

1. Tap **Menu** and tap **Edit Page**.
2. Tap **Menu** and tap **Edit Page Layout**.
3. In the area under Page Name, tap, then backspace to erase the name, and then type the new name.
4. Tap **Save**.

Duplicating a Page

1. Tap **Menu** and tap **Edit Page**.
2. Tap **Menu** and tap **Import/Copy Pages**.

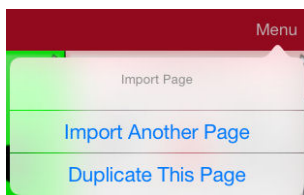

3. Tap **Duplicate This Page**. The New Page Name window will display the current name plus “Copy”.

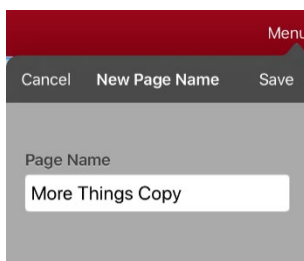

4. Tap the name and use the keyboard to enter an appropriate name for the duplicated page.
5. Tap **Save**. The duplicated page will be displayed with the new name.
6. Edit the page as needed.
7. When you finish, tap **Done** to exit Edit Mode.

Loading Another Page

1. Tap **Menu** and tap **Edit Page**.
2. Tap **Menu** and tap **Load Another Page**. A list of available pages opens.
3. Scroll through the list and select the page you want to load.
4. Tap **Done**.

Note: This page is now available to copy buttons or make additions or changes to your vocabulary.

Creating a New Blank Page

1. Tap **Menu** and tap **Edit Page**. The Page is now in Edit Mode.
2. Tap **Menu** and tap **Add New Page**. A menu provides two options.

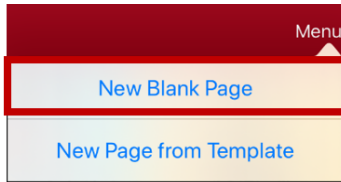

3. Select **New Blank Page**.
4. Tap the **Page Name** field and use the keyboard to give the page a name.
5. Select how many rows and columns you want.
Note: The number of rows and columns from the page currently displayed appear by default. Select different numbers if appropriate.
6. Tap the **Background Color** field and select a color.
7. Select an image (*optional*).
8. Tap **Save**. A new page will appear with blank buttons.
9. Start creating buttons on this page.
10. When you finish, tap **Done**.

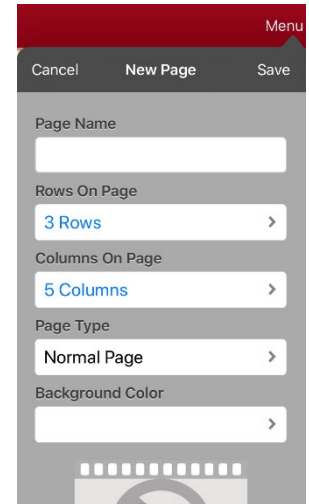

Creating a New Page from a Navigate Action

1. Display the page from which you want to navigate.
2. Tap **Menu** and tap **Edit Page**.
3. Tap the location for a button that will navigate to the page you want to create.
4. Tap **Edit This Button**. The Edit Button dialog opens.
5. Enter a button label and select or import an image.
6. Scroll down to the Button Actions section and tap the existing action to open the list of available actions.
7. Select the **Navigate** action to open the list of existing pages.
8. Tap the **+** in the upper right corner to create the new page.
9. Enter a page name and adjust the number of rows and columns.
10. Tap **Save**, select **No Animation**, and tap **Save** again.
11. To verify that the button navigates to your new page, tap **Done** to exit Edit Mode and then tap the button to navigate to the new page.
12. Tap **Menu**, tap **Edit Page**, and add buttons to the page.

Choosing a New Keyboard

1. Tap **Menu** and tap **Edit Page**.
2. Tap **Menu** and tap **Import/Copy Pages**.
3. Tap **Import Another Page**.
4. Tap the vocabulary file that contains the keyboard you want and tap the appropriate page to import.
Note: WordPower files have alternative pages (for example, QWERTY vs. ABC) within the same file. Simply edit the linking button to navigate to the new page **or** follow steps 6, 7, and 8.
5. Tap **Import**.
6. Edit the original keyboard button and have it navigate to the new keyboard page.
7. Edit the linking button to navigate to the new page.

Copying a Page from a Different Vocabulary File

There are times that borrowing previously created pages could be a time saver. TouchChat allows you to import multiple pages at one time.

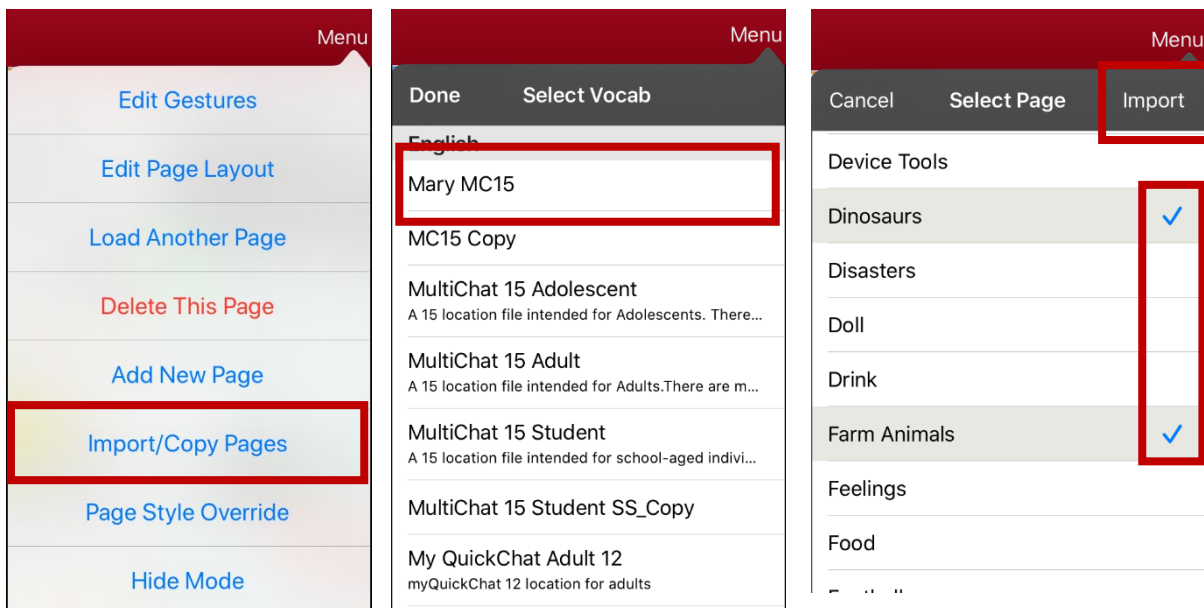

1. Have your vocabulary file open.
2. Tap **Menu** and tap **Edit Page**.
3. Tap Menu and tap **Import/Copy Pages**.
4. Tap **Import Another Page**.
5. Tap the vocabulary file that contains the page you want and tap the appropriate pages to import. A checkmark will appear following each page you tap.



6. Tap **Import** and tap **Done**.
7. While still in Edit Mode, tap the button that you want to navigate to the imported pages.
8. Tap **Edit This Button**.
9. Give the button a label and, if needed, an icon and make any style changes you want.
10. Scroll down to Button Actions, tap **Add**, and then tap **Navigate**.
11. Tap the page you imported.
12. Tap an animation or **No Animation**.
13. Tap **Save** and tap **Done**.

Adding a Gesture to a Page

1. Tap **Menu** and tap **Edit Page**.
2. Tap **Menu** and tap **Edit Gestures**.
3. Tap **+**.
4. Add a label and message.
5. To add gestures to an entire vocabulary file at one time, tap **Apply to All Pages**.
6. Tap the **Gesture Type** field and tap the type you want. A check mark will appear following the type you select.
7. Tap **Add** and select the gesture action you want.

Note: To delete a gesture action, tap **Edit** and tap the action you want to delete. The delete icon  will be displayed in front of the action. Tap the delete icon  to delete the action.

8. Tap **Save** and tap **Done**.

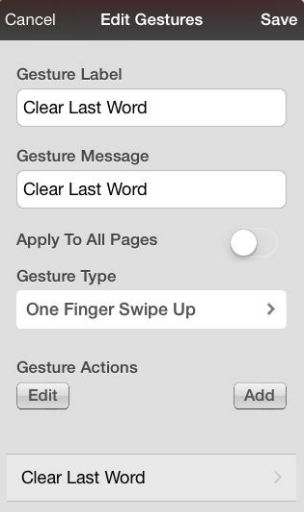

Cancel Edit Gestures Save

Gesture Label
Clear Last Word

Gesture Message
Clear Last Word

Apply To All Pages

Gesture Type
One Finger Swipe Up >

Gesture Actions
Edit Add

Clear Last Word >

Overriding the Background Color of a Page

Use this procedure to change the background color of all pages in a vocabulary. This is especially useful if you increase the space around buttons, revealing more of the background. For information on adjusting the button margin, see “Adding Extra Space around Buttons” on page 68.

1. Tap **Menu** and tap **Edit Page**.
2. Tap **Menu** and tap **Page Style Override**. The Vocab Override window displays color override options.

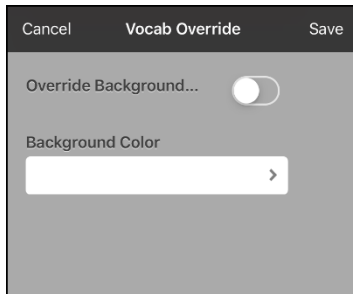

3. Select the **Background Color** box to open a list of colors.
4. Select a color. The color will appear in the Background Color box.
5. To override the default background color, turn **Override Background** on.
6. Tap **Save** and tap **Done**.

Hint: You can switch between the default page background colors and the override color as needed by toggling **Override Background** on and off.

Working with Special Pages

You can set any vocabulary page as a special page.

- Set any vocabulary page as your home page.
- Use any vocabulary page as a template.

Changing Your Home Page

1. Go to the page you want to use as your home page.
2. Tap **Menu** and tap **Edit Page**. The page is now in Edit Mode.
3. Tap **Menu**. The Edit Page menu opens.

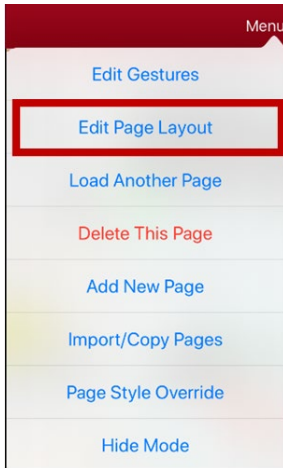

4. Tap **Edit Page Layout**. The Edit Page window opens.



5. Tap the current Page Type. The Page Type menu opens.

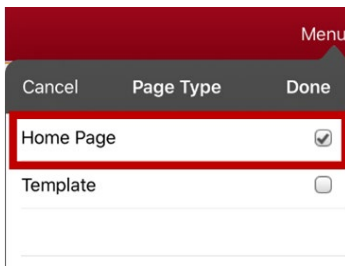

6. Select **Home Page**.
7. Tap **Done** to complete the change and tap **Done** to exit Edit Mode.

Setting a Page as a Template

You can use an existing vocabulary page as a template to create new pages quickly.

1. Go to the page you want to use as your home page.
2. Tap **Menu** and tap **Edit Page**. The page is now in Edit Mode.
3. Tap **Menu**. The Edit Page menu opens.

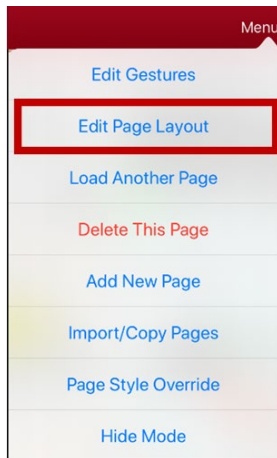

4. Tap **Edit Page Layout**. The Edit Page window opens.



5. Tap the current Page Type. The Page Type menu opens.

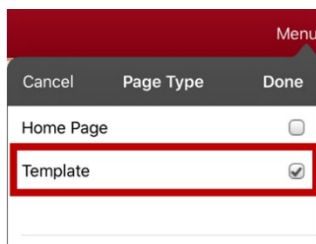

6. Select **Template**.
7. Tap **Done** and then tap **Save**.
8. The new template page is displayed with the name you gave it.
9. Add buttons and formatting to the page as needed.
10. When you finish, tap **Done** to exit Edit Mode.

Note: To use this template to create a page, see “Creating a New Page from a Template”.

Creating a New Page from a Template

1. Tap **Menu** and tap **Edit Page**. The page is now in Edit Mode.
2. Tap **Menu** and tap **Add New Page**. A menu provides two options.

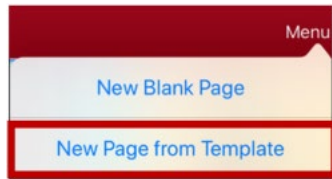

3. Select **New Page from Template**. The New Page Name window opens.

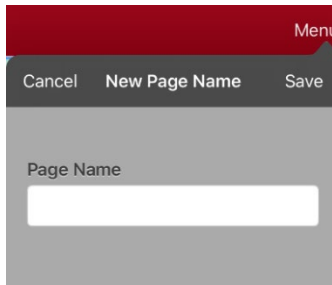

4. Tap the **Page Name** field, use the keyboard to enter a name for the new page, and tap **Save**.
Note: After you tap **Save**, the Save button will become disabled so you cannot accidentally tap it a second time. The message "Loading" will appear until the new page has finished loading.
5. The new page will be displayed with the buttons and formatting from the template and will display the name you entered.
6. Edit the new page as needed.
7. When you finish, tap **Done** to exit Edit Mode.

Trying to Delete Your Home Page

The home page is the starting point for all of the words in your vocabulary. For this reason, you cannot delete the home page. If you try to delete it, a message will advise you to set a different page as the home page.

Example #1: Try to Delete the Home Page from the Edit Page Menu

Tap **Menu** and tap **Edit Page**. Then tap **Menu** and select **Delete This Page**. A message will warn that you cannot delete the home page and advise you to set another page as the home page.

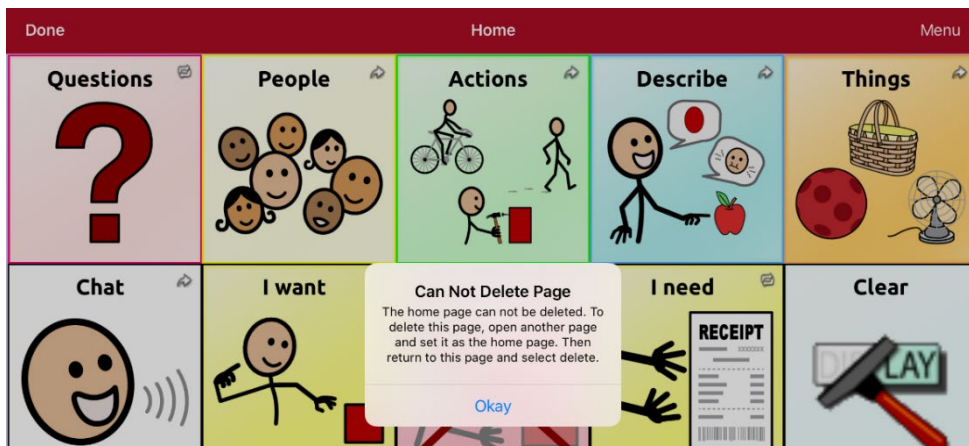

Select **Okay** to close the message. Then set another page as the home page. See “Changing Your Home Page” on page 75. If you still want to delete this page, you now will be able to.

Example #2: Try to Delete the Home Page from the Page Type Window

Tap **Menu** and tap **Edit Page**. Then tap **Menu** and select **Edit Page Layout**. In the Edit Page window, tap **Home Page** in the Page Type field. In the Page Type window, tap the Home Page checkmark. A message will warn that you cannot uncheck the box and advise you to set another page as the home page.

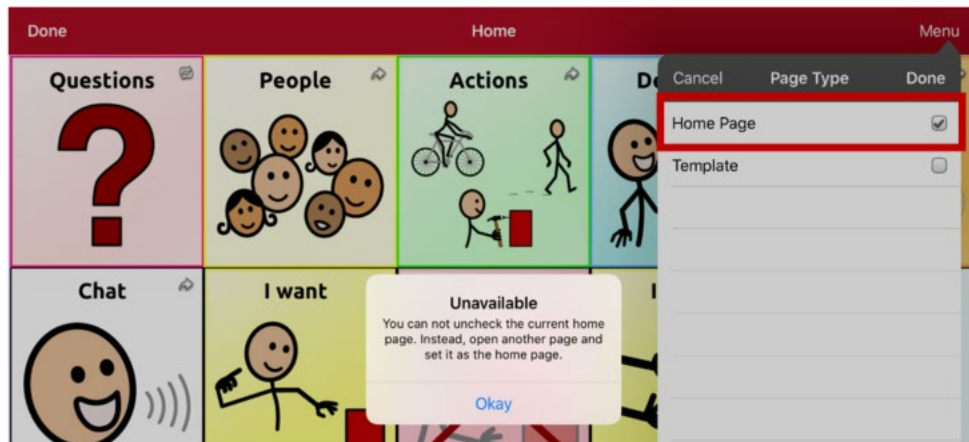

Select **Okay** to close the message. Then set another page as the home page. See “Changing Your Home Page” on page 75. If you still want to delete this page, you now will be able to.

Editing an Abbreviation Expansion

1. Tap **Menu** and tap **Edit Abbreviations**.
2. Tap **+**.

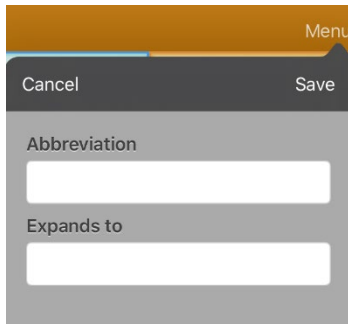
A screenshot of a mobile application's 'Edit Abbreviation' dialog box. The dialog has a dark grey header with 'Cancel' on the left and 'Save' on the right. Below the header, there are two text input fields. The first field is labeled 'Abbreviation' and the second is labeled 'Expands to'. The background of the dialog is a light grey color.

3. In the space under **Abbreviation**, type the abbreviated form.
4. In the space under **Expands to**, type the full word, phrase, or sentence that it will expand to.
5. Tap **Save** and tap **Done**.
6. To trigger the abbreviation, enter the abbreviation followed by a period from your vocabulary keyboard page.

Searching for a Word using Word Finder

When you don't know where a word is located in a vocabulary, use this procedure to search for the word and practice the sequence of buttons that lead to it.

1. From the vocabulary, select the **Keyboard**.
2. Select **Find Word**. Word Finder opens.

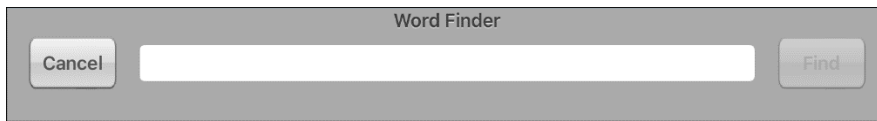

3. Enter the word you want to find.
 4. Select **Find**.
- Note:* If the word is not stored, the **Find** button will remain grayed out and you will not be able to select it.
5. The window will display the sequence of buttons to tap to activate the word.
 6. Tap the buttons to practice the motor pattern.

When you tap the first button in the sequence, your home page opens with the button highlighted. When you select the button, the next button in the sequence is highlighted. When you select that button, the next button is highlighted and so forth until you reach the end of the sequence.

Adding Acapela Vocal Smileys

Acapela-Group has created the capability of using Voice Sounds and Exclamations.

Adding a Sound

Sounds are produced by the speaker's voice for laughing, breathing, sneezing, coughing, or whatever sounds our voices can produce to mimic sounds we make in our daily lives. Sounds are always between two pound signs; for example: **#LAUGH02#** in capital letters and sometimes followed by numbers if there are more than one of the same kind. The children's voices have more sounds than adult voices.

Adding an Exclamation

Exclamations include a variety of letters and symbols. Type exactly what you see.

Finding a Vocal Smiley

To find the list of Acapela Vocal Smiley commands:

1. Go to <http://www.acapela-group.com/doc/Vocal%20smileys/excla.html>
2. Click the link to the appropriate language.
Important! The language you select must match the language of the voice you are using.
3. Select the specific Vocal Smiley you want.

Example: Add a Smiley Face and Laugh Sound to a Button

A button can be set up with the command in the message. However, if you use the "speech message" action, the command appears in the Speech Display Bar (SDB), which isn't ideal. A better way may be to set up a button with an emoticon symbol in the message.

For example, you could use a smiley face symbol. Note that you may need to go to **Settings > General > Keyboards** and add the Emoji keyboard so that you can type emoticon symbols. Once the button is set up with the emoticon and speech message, go to Pronunciations and add a pronunciation for the smiley face emoticon. Enter a command such as **#LAUGH02#** for the pronunciation.

The Pronunciation Editor can be found in **Menu > Edit Pronunciations > +**. Add the same Emoticon used on the button to the Word box and add the command—for example, **#LAUGH02#**—to the Pronounce As box.

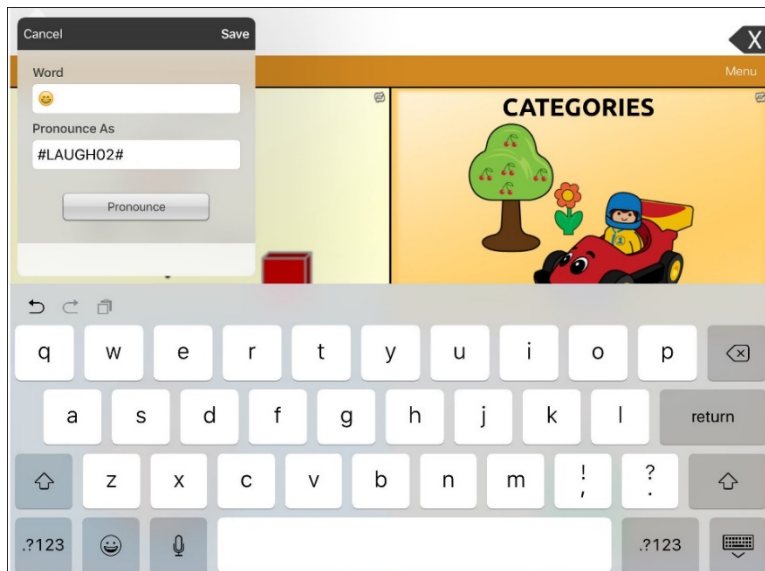

Now when you touch the button, the emoticon will appear in the SDB and the laugh sound will be heard.

Creating a Visual Scene

To create a visual scene, select a background image, set up the page, and add buttons.

Selecting a Background Image

Start by having the picture you want to use for the background image on the device. You can take a picture using your device if it has a built-in camera. Otherwise, transfer the picture to the device from a computer.

1. Tap **Menu** and tap **Edit Page**.
2. Tap the location to add a linking button (the button you wish to link to your visual scene) and tap **Edit This Button**.
3. Add a label, scroll down to the Button Actions section, and replace the existing action with **Navigate**.
4. Tap the **+** in the upper right corner to create your new visual scene page.
5. Enter a page name.
6. Adjust the number of rows and columns on the page. Choosing as many rows and columns as possible will make it easier to create buttons that fit with the images on the page.
7. Scroll down to **Import Image**.
8. Tap **Import Image** and take a picture or find the image you want. A thumbnail view of the image will appear above Import Image.
9. Tap **Save**, select **No Animation**, and tap **Save** again.
10. To verify that the button navigates to your new page, tap **Done** to exit Edit Mode.
11. Tap the button to navigate to the new page.
12. Tap **Menu** and tap **Edit Page**, and proceed to the next topic, "[Adding Buttons](#)".

Adding Buttons

Now with the background picture in place, using the blank buttons, buttons can be created that speak or move to other pages. In our example, create a button that speaks “Horse” whenever tapping on the horse in the picture (assuming we used a picture with a horse in it).

1. Tap the upper most left corner location that covers the ear.
2. Tap Create New Button.
3. Type **Horse** into the button message box.
4. Set the Transparent option to the **On** position. That way the scene behind it comes through.
5. Tap **Save**.
6. Tap the newly created button and choose **Change Button Size**. From here, you can adjust the button height and width so that it fits the entire image.
7. Tap **Save**.
8. Create the remaining buttons and re-size them to go along with the scene. All the buttons can have their own size and shape.
9. When you finish, tap **Done**.

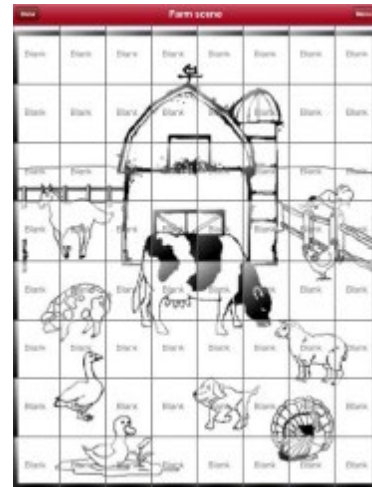



Creating a Whiteboard Page

Whiteboards can be used for drawing, collaborating, and sharing. To create a whiteboard page, create a new page that has a single button and select the Whiteboard button action.

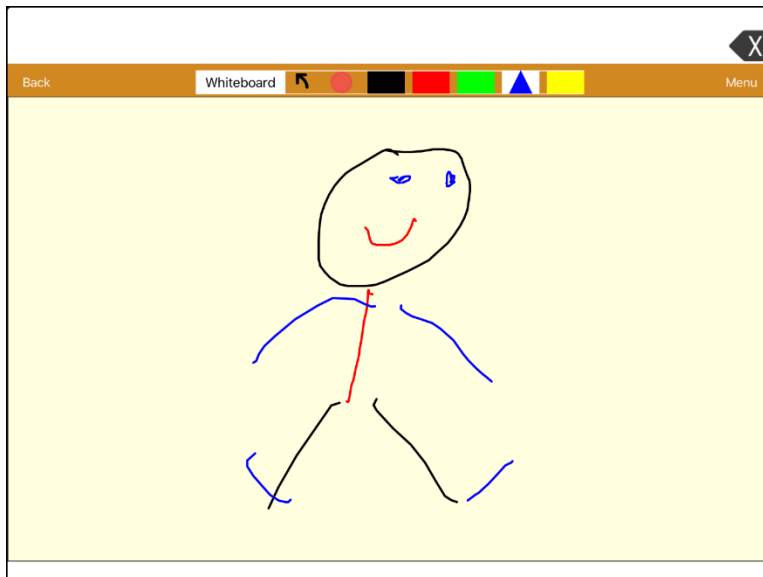
1. Tap **Menu** and tap **Edit Page**.
2. Tap the button you want to link to your whiteboard page and select **Edit This Button**.
3. Add a label, scroll down to the Button Actions section, and replace the existing action with **Navigate**.
4. Tap the **+** in the upper right corner to create your new whiteboard page.
5. Enter a page name and select **1 Row** and **1 Column**.
6. Tap **Save**, select **No Animation**, and tap **Save** again.
7. Tap **Done** to exit Edit Mode and tap the button to navigate to the new whiteboard page.
8. Tap **Menu**, select **Edit Page** and select **Create New Button**.
9. Scroll to the Button Actions section of the Edit Button window and replace the Speech Message action with the Whiteboard action.
10. Tap **Save**. Select **Done** to exit Edit Mode.
11. Use the Whiteboard tools at the top of the page to draw.



Tool	Function
Back	Return to the page with the button that links to the whiteboard.
Whiteboard	<p>Open a menu. Tap the whiteboard outside the drawing to close a menu.</p> <p>When there is no drawing on the whiteboard, the options are Color, Width, Save, and Load.</p> <ul style="list-style-type: none"> • Color: Select Black, Red, Green, Blue, or Yellow. • Width: Select Thin, Normal, or Thick to set the width (thickness) of the next line you draw. • Save: Save the current drawing. • Load: Load a saved drawing. <p>When a drawing is on the whiteboard, additional options are available: Clear, Undo, and Erase.</p> <ul style="list-style-type: none"> • Clear: Remove the entire drawing. • Undo: Remove the most recent addition or change. • Erase: Remove a portion of the drawing. When you select Erase, the eraser is selected.
	Undo the most recent addition or change.
	<p>Erase a portion of the drawing. Select this tool and then tap any portion of the drawing to erase it.</p> <p>You can also drag across a portion of the drawing to erase that portion. To change the width of the eraser, tap the control once to change the width from Thin to Normal; tap the control again to change the width to Thick.</p>
	Select the color of the next line you draw. When a color is selected, the color rectangle changes to a triangle. The width of the triangle changes when you change the Width setting.

Changing Whiteboard Settings

To change any of the Whiteboard settings, tap **Menu**, tap **Settings**, and scroll to the Whiteboard section.

Setting	Description
Disable drawing in split view	When turned on, you cannot draw on the whiteboard page when split view is enabled in iOS.
Scale drawing in split view	When turned on, whiteboard drawings are scaled according to the relative size of the app page when split view is enabled in iOS.
Reload last drawing	When turned on, the most recent drawing made on the whiteboard appears when you open Whiteboard.
Autosave drawing	When turned on, whiteboard drawings are saved automatically.

Enlarging Text in the Speech Display Bar

There are a number of ways to enlarge text in the Speech Display Bar (SDB).

Changing Text Size or Number of Lines in the SDB

1. Tap **Menu** and tap **Settings**.
2. Scroll to the Speech Display Bar section.
3. Under Font Size, select a larger font size. Font sizes range from 14 Point to 72 Point.
4. Under Number of Lines, select the number of lines of text you want to appear in the Speech Display Bar. The number of lines ranges from 1 Line to 10 Lines.

Note: If you try to select a font size and number of lines that together would make the SDB larger than the screen can accommodate, the font size will be adjusted down automatically to a value that allows the SDB to fill no more than 60% of the screen. For example, if you select 10 lines with a 72-point font, the font will be adjusted to a smaller size.

Creating a Tap Action

Create a tap action to enlarge the text in the SDB.

1. In TouchChat, tap **Menu** and tap **Settings**.
2. Scroll down to the Speech Display Bar section.
3. Under Tap Action, tap **Speak and Enlarge Text**.
4. Tap the SDB again to close the enlarged window.

Highlighting Words as They are Spoken in the SDB

To help with literacy, the Highlight Spoken Word setting allows users to see the words highlighted in the SDB as they are spoken. When you select a color, words will be highlighted in that color one at a time in the SDB as they are spoken.

Note: Some voices do not support this feature. Word highlighting is disabled when scanning prompts are spoken; but it is enabled when scanned button actions add text to the SDB.

1. Choose **Menu > Settings** and scroll to the Speech Display Bar section.

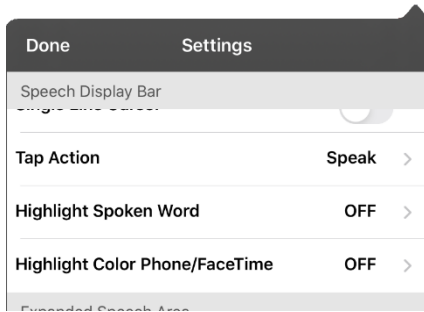

2. Select **Highlight Spoken Word**. The setting OFF and a list of colors opens. OFF is the default setting.

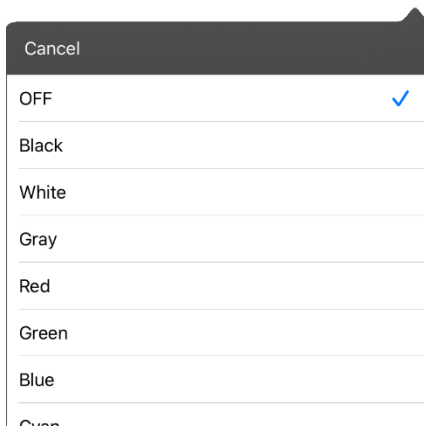

3. Choose a color. The selected color appears in the setting.

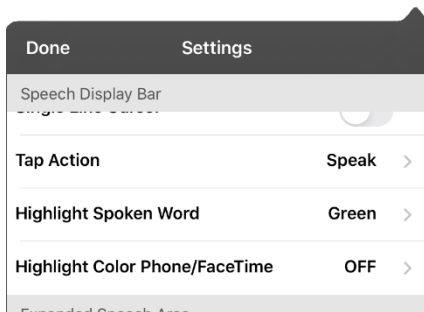

4. Select **Done**.
5. As you select words from a page, they are highlighted one at a time in the SDB in the color you selected.

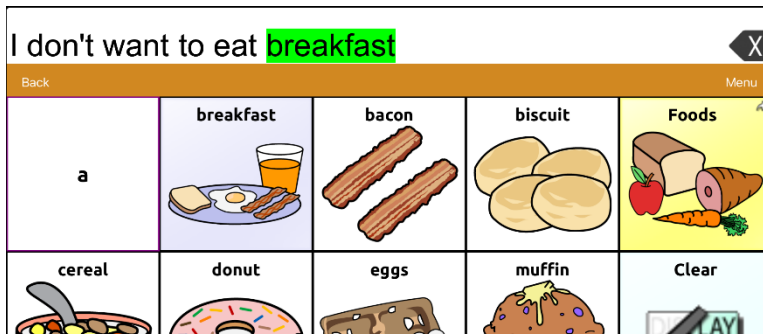

- To change the highlight color, choose **Menu > Settings**, scroll to the Speech Display Bar section, select **Highlight Spoken Word**, choose a different color, and select **Done**.
- If you pause speech, the last spoken word will remain highlighted.
- To turn highlighting off, choose **Menu > Settings**, scroll to the Speech Display Bar section, select **Highlight Spoken Word**, choose **OFF**, and select **Done**.

Highlighting Words as They are Spoken during a Telephony Call

To help with literacy, the Highlight Color Phone/FaceTime setting allows users to see words highlighted as they are spoken during a telephony call. Otherwise, there is no voice output on the device user's end when they are speaking allowing them to ensure their message was spoken.

1. Choose **Menu > Settings** and scroll to the Speech Display Bar section.

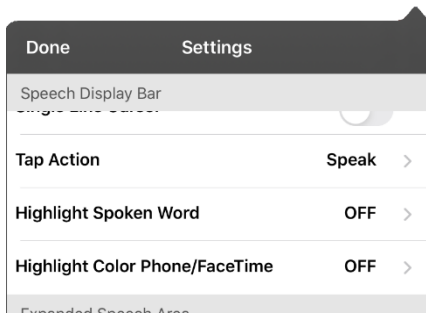

2. Select **Highlight Color Phone/FaceTime**. The setting OFF and a list of colors opens.

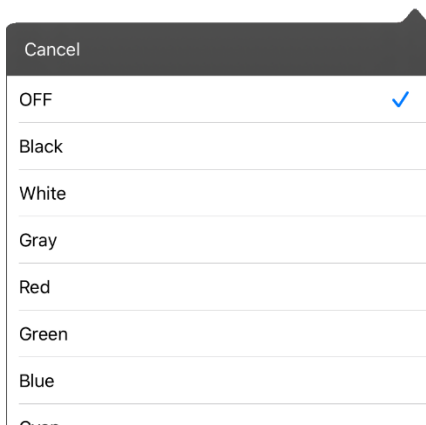

3. Choose a color. The selected color appears in the setting.

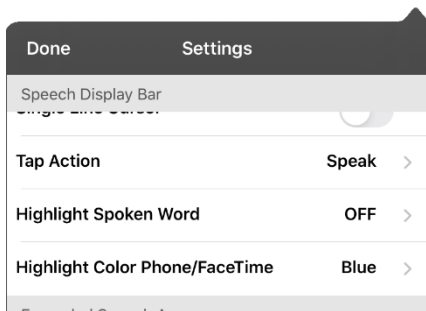

4. Select **Done**.
5. As you select words during a call, they are highlighted one at a time in the SDB in the color you selected.
 - To change the highlight color, choose **Menu > Settings**, scroll to the Speech Display Bar section, select **Highlight Color Phone/FaceTime**, choose a different color, and select **Done**.
 - To turn highlighting off, choose **Menu > Settings**, scroll to the Speech Display Bar section, select **Highlight Color Phone/FaceTime**, choose **OFF**, and select **Done**.

Setting up Switch Scanning in TouchChat

As an alternative to directly selecting each button on the screen, the TouchChat app offers single switch and two-switch scanning.

Setting up One or Two Switches

You can set up one or two wired or wireless switches to work with scanning in the TouchChat app.

1. Connect or pair each switch.

Wired switch: Plug the switch into switch jack A or switch jack B on the device. If you are using two switches, plug a switch into each jack.



Cords and cables are potential entanglement or strangulation hazards. Please consider this prior to placing these items with device users.

Wireless switch: Turn the switch on and pair it with your device according to the instructions that came with your switch.

2. To enable scanning, choose **Menu > Settings**, scroll to the **Scanning** section, and turn **Scanning Enabled** on.
3. To set up the switch or switches, select **Configure Switches**. The switch access settings are displayed.

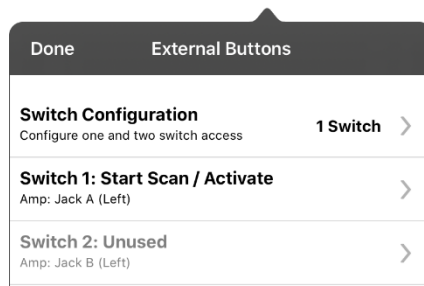

4. Choose **Switch Configuration** and choose the number of switches you plan to use.

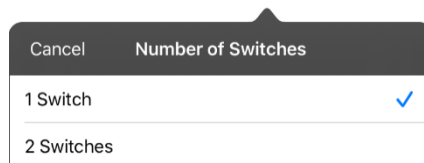

If you select **1 Switch**, Switch 1 will be active and Switch 2 will be grayed out. If you select **2 Switches**, both Switch 1 and Switch 2 will be active.

Note: When “(Left)” or “(Right)” appears in a Switch 1 or Switch 2 setting, it does not affect how you should set up the switch. It only refers to the internal technical configuration of the switch, which you can disregard.

5. To set up Switch 1, tap **Switch 1:** The prompt “Press any switch” will appear. Press the switch intended to start and stop the scan.
6. To set up Switch 2, tap **Switch 2:** The prompt “Press any switch” will appear. Press the switch intended to make your choice or activation.

Note: To use the touchscreen as either Switch 1 or Switch 2, tap the touchscreen at the “Press any switch” prompt.

7. Adjust additional scan settings as necessary.

Using the TouchChat Scanning Settings

To access the options for customizing a scanning technique, choose **Menu > Settings**. Scroll to the **Scanning** section.

Setting	Description
Scanning Enabled	Turns scanning on or off. You must turn scanning on to access the other scanning settings.
Configure Switches	Set up one or two external switches or the touchscreen to work with scanning.
Auto-Scan	When Auto-Scan is turned on, scanning activates automatically. When Auto-Scan is turned off, a switch activation is required to move the scan through each button, one at a time.
Auto Restart	When Auto-Scan and Auto Restart are both turned on, a scan cycle restarts automatically after an activation.
Auditory Scan	Turns on audio feedback during scanning.
Prompt Voice	Allows you to choose the prompt voice.
Prompt Voice Rate	Provides a slider that allows you to set the Prompt Voice rate. Move the slider to the right for a higher voice rate or to the left to lower the rate.
Prompt Voice Pitch	Sets the pitch of the prompt voice. Available settings are Lowest, Lower, Low, Normal, High, Higher, and Highest.
Pause Between Words (Auditory Scan)	When Auditory Scan is turned on, Pause Between Words sets the amount of time between words in auditory prompts. Available settings are No Pause, 1 Second, 2 Seconds, and 3 Seconds.
Scan Speech Display Bar	When Scan Speech Display Bar is turned on, a scan will include the Speech Display Bar. When turned off, a scan will skip the Speech Display Bar.
Skip Empty Cells	When Skip Empty Cells is turned on, a scan will skip empty button areas. When turned off, a scan will include empty button areas.
Scanning Type	Sets the scanning pattern to Sequential or Row/Column.
Scan Speed	Sets the amount of time your device takes to move from one button, row, or column to the next in a scan. Available settings range from 0.2 Seconds to 10 Seconds. For example, if you selected 1.0 Seconds , a scan would take one second from the time one button is highlighted until the next button is highlighted.
Number of Rescans	Sets the number of times the device scans the page automatically. Once you reach the set number of re-scans, the scan will stop until you activate a switch again. Available settings are 0, 1, 2, 3, 4, 5, 10, and 100.

Using Auto-Scan

You can choose to have scanning activate automatically, or you can choose to either hold the switch or step to each location. To set scanning to activate without holding a switch, choose **Menu > Settings**, scroll to the **Scanning** section, and turn **Auto-Scan** on. When Auto-Scan is turned off, a switch activation is required to move the scan through each button, one at a time.

Selecting the Scan Pattern

To select the scanning pattern, choose **Menu > Settings**, scroll to the **Scanning** section, and select **Scanning Type**. Then select **Sequential** or **Row/Column**.

Using Sequential Scan Mode: A sequential scan steps through the buttons from left to right beginning in the first row. When the button you want is highlighted, activate your switch.

Using Row/Column Scan Mode: A row/column scan highlights each row of buttons beginning with the top row and move down the screen. When the row that contains the button you want is highlighted, activate your switch. The scan will then step through the buttons from left to right across the row. When the button you want is highlighted, activate your switch.

Including the Speech Display Bar (SDB) in Scans

To include the SDB in scans, choose **Menu > Settings**, scroll to the Scanning section, and turn **Scan Speech Display Bar** on.

Configuring Empty Cells Scans

To turn scanning of empty button areas on or off, choose **Menu > Settings**, scroll to the **Scanning** section, and select **Skip Empty Cells**. When selected, scanning will skip over an area without a button or a button that only has a speech message action but no text.

Setting Scan Timing

Scan speed is the amount of time your device takes to move from one button, row, or column to the next in a scan. To set the scan speed, choose **Menu > Settings**, scroll to the **Scanning** section, and select **Scan Speed**. For example, if you selected **1.0 Seconds**, a scan would take one second from the time one button is highlighted until the next button is highlighted.

Configuring Re-scans

Select the number of times you want your device to scan the page automatically. Once you reach the set number of re-scans, the scan will stop until a switch is activated again. To set the number of re-scans, choose **Menu > Settings**, scroll to the **Scanning** section, and select **Number of Rescans**. Choose the appropriate number of rescans.

Turning on Auto Restart

When Auto-Scan and Auto Restart are both turned on, a scan cycle restarts automatically after an activation. To turn on auto restart, choose **Menu > Settings**, scroll to the **Scanning** section, and turn **Auto Restart** on.

Setting Auditory Scan

This option enables audio feedback during scanning. To set auditory prompts, choose **Menu > Settings**, scroll to the **Scanning** section, and turn **Auditory Scan** on. If you are scanning, simply activate your switch. To retrieve a message, activate the switch again after you hear the prompt.

Choosing and Adjusting a Prompt Voice

When choosing a voice to use for auditory prompts, it can be helpful to choose a different voice than the one the system uses for speaking messages. To change the voice, choose **Menu > Settings**, scroll to the **Scanning** section, select **Prompt Voice**, and select the voice you want.

To adjust the rate at which the prompt voice speaks, move the **Prompt Voice Rate** slider to the right for a higher voice rate or to the left to lower the rate until the prompt voice speaks at the rate you want.

To adjust the pitch of the prompt voice, choose **Menu > Settings**, scroll to the **Scanning** section, and select **Prompt Voice Pitch**. Then choose the pitch you want.

Blocking and Restoring Access to the Editing Menus

There may be times when you need to block access to the Editing menus. To do this, the **Use Menu Passcode** setting can be turned on or off. When this setting is turned on, the Menu and Vocab items can only be accessed by entering a password.

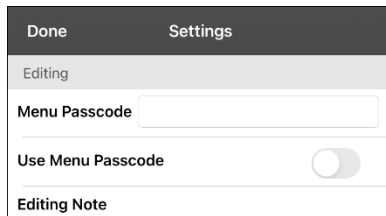

To password-protect the Editing menus:

1. In TouchChat, tap **Menu** and tap **Settings**. The Settings menu will open.
2. Under “Editing”, turn **Use Menu Passcode** on.
3. Tap in the Passcode field to open a keyboard.
4. Enter your password and tap **Done** on the keyboard.
5. Tap **Done** on the Settings menu.

Now when the user taps either **Menu** or **Vocab**, a password prompt will be displayed.

To reset your password:

If you forget your password, enter the numeric sequence **72584556** to overwrite the existing password. Then you can create a new password.

To remove password protection from the Editing menus:

1. In TouchChat, tap **Menu** or **Vocab**. The Password prompt will be displayed.
2. Enter your password. The Settings menu will open.
3. Turn Use Menu Passcode off.
4. To remove the password, tap in the Passcode field to open the keyboard. Use the Keyboard backspace key  to remove the password.
5. Tap **Done** on the keyboard.
6. Tap **Done** on the Settings menu.

Non-Dedicated Device Alternative: Allow Editing in the iPad Settings

You can hide the editing menus completely by turning off **Allow Editing** in the iPad settings.

- When Allow Editing is turned off, **Menu** and **Vocab** are completely hidden.
- When Allow Editing is turned on, Menu and Vocab are accessible. You can then use the TouchChat settings to enable or disable access.

To change the Allow Editing setting, tap the **Home** button on the device and choose **Settings > TouchChat > Allow Editing**.

Working with Profiles

Profiles provide a snapshot of the current settings of the system to be saved for easy access at a later time. You can save multiple profiles to be used when needed. Creating multiple profiles allows you to switch between groups of settings.

Creating and Saving a Profile

1. Configure the settings you want associated with the profile. This includes the vocabulary file, settings, language, etc.
2. Go to **Menu > Settings > Save Profile**. The Profile Name window will open.

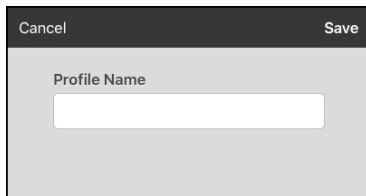

3. Tap in the Profile Name field to open a keyboard.
4. Enter a name for the profile (for example, “Mary’s Profile”).
5. Choose **Save**. A profile will be created for Mary with all the current settings.

Note: To create a second profile (for example, “John’s Profile”), repeat these steps, making new settings changes to associate with this profile.

Loading a Profile by Navigating Menus

To load a profile that you previously created:

1. Go to **Menu > Settings > Load Profile**. Profiles that you have created will be listed.

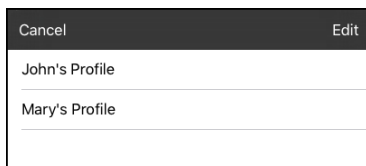

2. Tap the profile name you want. The associated settings will be loaded.

Loading a Profile by Tapping a Button

If you create multiple profiles and load them using a button action, you can switch between profiles without navigating the menus.

1. Go to the page that includes the button you want to use.
2. Choose **Menu > Edit Page**.
3. Tap the button you want to add the action to.
4. Tap **Edit This Button**.
5. Add a label, message, and image as needed
6. Scroll down to the Button Actions section.
7. Tap **Add**.
8. Scroll through the list of actions and tap **Select Profile**.
9. Tap **Save** and **Done**.

Renaming or Deleting a Profile

1. Go to **Menu > Settings > Load Profile**. Profiles that you have created will be listed.

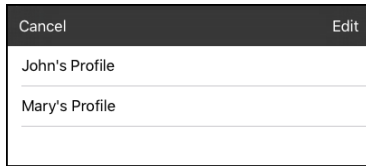

2. Choose **Edit**. The delete icon  will appear to the left of each profile name.



3. Tap the delete icon  for the profile you want to rename. Rename and Delete buttons will appear.

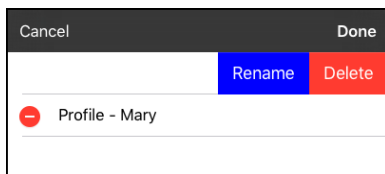

4. Rename or delete the profile.

To rename the profile: Choose **Rename**, enter the new name in the Profile Name field, and choose **Save**.

To delete the profile: Choose **Delete**. The profile will be deleted immediately.

Modifying a Profile

1. Make the changes you want associated with the profile.
2. Go to **Menu > Settings > Save Profile**. The Profile Name window will open.
3. Tap in the Profile Name field to open a keyboard.
4. Enter the profile's original name and choose **Save**. A message will inform you that the file name already exists.

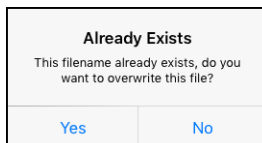

5. Choose **Yes**. The changes will be saved.

Changing Screen Orientation

Important! TouchChat screen orientation settings do not affect iOS® or iPadOS® screen settings. However, when screen orientation is locked in iOS or iPadOS, it is locked in TouchChat as well, regardless of the TouchChat setting.

***Non-Dedicated Devices:* Locking and Unlocking Screen Orientation in Control Center**

To lock screen orientation:

1. Pull down Control Center from the top right of the screen.
2. Make sure the device is in the orientation you want to lock it to.
3. Tap the **Orientation Lock** icon . The icon will turn red.

To unlock screen orientation:

1. Pull down Control Center from the top right of the screen.
2. Tap the **Orientation Lock** icon . The icon will turn white.

Changing TouchChat Settings

TouchChat settings are located by going—within the TouchChat app—to **Menu > Settings**. From the TouchChat Settings screen, scroll to see all available settings. When you finish changing settings, tap **Done** in the upper left corner of the settings.

Note: For Scanning settings, see “Using the TouchChat Scanning Settings” on page 91.

Profiles

Setting	Description
Save Profile	Allows you to save the current settings as a profile.
Load Profile	Allows you to load, rename, or delete a profile.

Navigation

Setting	Description
Page Animation	When turned on, this setting allows you to navigate a page by scrolling up, down, right, or left.
Allow Gestures	When turned on, this setting allows you to add a gesture to a page such as swiping left or right to engage an action.
Gesture Pop Sound	When turned on, this setting provides audible feedback when a gesture is performed.
Button Click Sound	When turned on, this setting provides audible feedback when a button is selected.
Button Navigation Icons	When turned on, this setting displays the small navigation arrows in the top right corner of all buttons. When the setting is turned off, the arrows are hidden.





Page Size

Setting	Description
Status Bar	When turned on, this setting displays the device status bar above the Speech Display Bar.
Keyguard Inset	When turned on, this setting adjusts the display for a keyguard.

Editing

Setting	Description
Menu Passcode	When applicable, enter the password you want to use in this field.
Use Menu Passcode	When turned on, this setting requires a password to access the Editing menus.

Speech

Setting	Description
Voice	<p>Because there are many voice options, voices are downloadable. If you only download and install the voices you need, you can save a lot of storage space on your device.</p> <p>The Voice setting displays the voice currently selected. To download and install a different voice, tap Voice to open a list of available voices. To hear how a voice sounds, select the  icon. Listen to several voices. When you find the voice you want, select the  icon to download and install it.</p> <p><i>Note:</i> Some voices are only available at a cost. These voices must be purchased from the Upgrade Store before they are available in the Voice list.</p>
Rate	<p>Use the slide bar to modify the rate of speech.</p> <p>Test: To hear how the selected voice sounds at the modified rate, select Test.</p> <p>Defaults: To restore all speech settings to their default values, select Defaults. A warning appears. If you want to restore <i>all</i> the default speech settings, select Continue. If you want to keep the current speech settings, select Cancel.</p>
Voice Pitch	<p>You can make a voice sound different by modifying the pitch. Select the pitch you want: Lowest, Lower, Low, Normal, High, Higher, or Highest. <i>Note:</i> This option is not available for all voices.</p>
Pause Between Words	<p>You can add a speech delay between individual words. <i>Note:</i> This option is not available for all voices.</p>
Phone/FaceTime Voice	<p>Select the voice you want to use for phone calls.</p> <p>The Phone/FaceTime Voice setting displays the voice currently selected. To download and install a different voice, tap Phone/FaceTime Voice to open a list of available voices. To hear how a voice sounds, select the  icon. Listen to several voices. When you find the voice you want, select the  icon to download and install it.</p>

Speech Display Bar

Setting	Description
Hide Speech Display	When turned on, this setting hides the entire SDB.
Allow Copy/Paste	When turned on, this setting gives the user the option to copy/paste from the SDB.
Auto Capitalization	When turned on, this setting capitalizes the first word of a sentence automatically.
Show Icons	Choose this setting if you want to display icons with text in the SDB.
Hide Delete Button	When turned on, this setting hides the SDB's Delete button.
Font	Select one of the 7 available fonts for use for text in the SDB.
Font Size	Determines the size of the font that appears in the SDB. Font sizes range from 14 Point to 72 Point. <i>Note:</i> If you try to select a font size and number of lines that together would make the SDB larger than the screen can accommodate, the font size will be adjusted down automatically to a value that allows the SDB to fill no more than 60% of the screen.
Font Color	Choose one of the 12 available font colors to apply to text in the SDB.
Background Color	Choose one of the 12 available background colors to apply to the SDB.
Delete Button Color	Choose one of the 14 available colors (including Clear) to apply to the Delete button.

Setting	Description
Number of Lines	Choose how many lines of text you want to appear in the SDB. The number of lines ranges from 1 Line to 10 Lines.
Single Line Cursor	Choose this setting if you want a cursor to appear in the SDB.
Tap Action	Choose Speak , Speak and Enlarge Text , or No Action when the SDB is tapped.
Highlight Spoken Word	Select a color to see the words highlighted in the SDB as they are spoken.
Highlight Color Phone/FaceTime	Select a color to see the words highlighted in the SDB as they are spoken during a telephony call.

Expanded Speech Area

Setting	Description
Font	Select one of the 7 available fonts for use for text in the expanded speech area.
Font Size	Determines the size of the font that appears in the expanded speech area.
Font Color	Choose one of the 12 available font colors to apply to text in the expanded speech area.
Background Color	Choose one of the 12 available background colors to apply to the expanded speech area.

Speak

Setting	Description
Speak Characters	When this setting is turned on, each character will be spoken as entered.
Speak Words	When this setting is turned on, each word will be spoken as entered.
Speak Sentences	When this setting is turned on, each sentence will be spoken as entered.
Auto Clear	Set what happens to text in the Speech Display Bar after it is spoken. Off: Spoken text remains in the Speech Display Bar until you clear it. Immediate: Text is cleared automatically from the Speech Display Bar as soon as it is spoken. After Next Activation: Text is cleared automatically from the Speech Display Bar when you activate a button in your vocabulary.
Prevent Interruption	When turned on, this setting will prevent interruptions of speaking a sentence if you accidentally hit another button while it is speaking.

Data Logging

Setting	Description
Enable Logging	Turn on data logging, allowing your device to collect language usage data which you can upload to the Realize Language website for web-based analysis or save to a file to analyze manually.
Privacy Password	Set or change your data logging privacy password.
Clear Log	Clear usage data for the current person.
Realize Language Setup	Upload data collected for a person to the Realize Language website for analysis.

Buttons

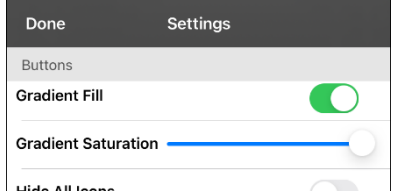
Setting	Description
Activate on Release	When this setting is turned on, a button will not activate until released, rather than on touch.
Dwell Time	Controls the delay before a button press is recognized in case a user needs to slide across multiple buttons before pressing the intended button.
Release Time	<i>Buttons:</i> All buttons are disabled for specified period of time after each button activation to prevent accidental double button activations. <i>SDB:</i> The SDB is disabled for the specified period of time after the user taps the SDB to prevent accidental speaking of words displayed in the SDB twice.
Force Font Size	When this setting is turned off, the button label font size is automatically reduced as needed to allow the entire label to fit into the button area.
Highlight Touch	When this setting is turned on, the button that is touched is highlighted briefly when activated.
Gradient Fill	When this setting is turned on, button colors gradually blend into each other. 
Gradient Saturation	Use the Gradient Saturation slider to adjust the saturation/opacity (intensity) of the gradient. Moving the slider to the right makes colors appear more saturated/opaque (intense). Moving the slider to the left makes colors appear less saturated/opaque (pale).
Hide All Icons	When turned on, this setting will hide all of the icons from the buttons and only the text will appear. Note that hiding the button icons will also force the SDB setting “Show Icons” off.
Show Hidden Buttons	When turned on, buttons that have been hidden will be displayed.
Show Grid	When this setting is turned on, a visible grid appears in blank button areas.
Dynamic Grammar Labels	When turned on, Dynamic Grammar Labels displays on button labels the changes that will be made to words when grammar rules are applied. See “Appendix A: Advanced Grammar Features”.
Button Margin	To add extra space around buttons, select a margin size between 1 Point and 100 Point. The default size is None.
SymbolStix Skin Tone	Change the skin tone of people displayed on buttons.

Whiteboard

Setting	Description
Disable drawing in split view	When turned on, you cannot draw on the whiteboard page when split view is enabled in iOS.
Scale drawing in split view	When turned on, whiteboard drawings are scaled according to the relative size of the app page when split view is enabled in iOS.
Reload last drawing	When turned on, the most recent drawing made on the whiteboard appears when you open Whiteboard.
Autosave drawing	When turned on, whiteboard drawings are saved automatically.

Social Networking

This setting is available on non-dedicated devices only.

Setting	Description
Allow Social Networking	When turned on, this setting allows you to share text from the SDB to social networks.

Amp Connect

Setting	Description
Select Amp	Select your amplifier name to make a Bluetooth connection to the TouchChat software for getting proper battery status readings.
Set up Amp	Set left and right speaker volume, bass, and treble.

Analyzing Language Development

You can use the data logging capabilities of your device to collect information on a person's language development. Then you can upload that information to the Realize Language™ website.



This process allows you to monitor, measure and maximize the person's use of the device.

Using the Realize Language Website

Realize Language is a subscription-based online service that organizes and analyzes information and presents the results in easy-to-understand graphic formats that provides valuable insights into each person's language development. Using this service from your computer, you can

- Track the person's progress and communication development over time
- Compare different aspects of communication automatically
- Create a detailed summary of performance
- Share information with others
- Quickly create reports that anyone can understand

To learn more, go to the Realize Language website: <https://realizelanguage.com/info/>

To view or download the *Realize Language Starter's Guide*, go to <https://realizelanguage.com/info/support>

For Customer Support:

If you have a problem with the Realize Language website, email support@realizelanguage.com.

If you have a problem with your device, call Saltillo technical support at 1-800-382-8622 or email service@saltillo.com.

Turning on Data Logging from Your Device

When data logging is turned on, your device collects language usage data which you can upload to the Realize Language website for web-based analysis or save to a file to analyze manually.

1. In TouchChat, tap **Menu** and tap **Settings**. The TouchChat Settings screen will be displayed.
2. Under Data Logging, turn on **Enable Logging**.

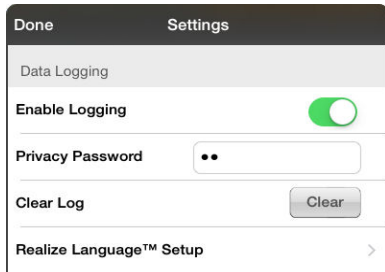

When data logging is turned on, the data logging icon appears in the Speech Display Bar.

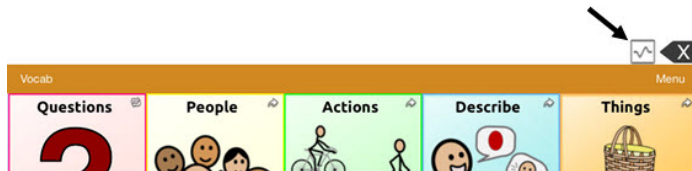

Important! If you plan to use the Realize Language website to analyze data, set up a person before you start collecting data.

Creating a Privacy Password

Data logging provides the option to create a privacy password to protect the data you collect against unauthorized access.

1. Under Data Logging, tap the password box located to the right of **Privacy Password**. A cursor will appear in the password box and keyboard will be displayed.
2. Type the privacy password you want to use and tap **Done**. The Confirm New Privacy Password prompt will be displayed.
3. Type your password again and tap **Enter**. “New Password Set” will be displayed.
4. Tap **OK** to close the message.

Non-Dedicated Devices: Uploading Data for Analysis

Upload data collected for a person to the Realize Language website for analysis.

1. Tap **Realize Language™ Setup** to open the Realize Language Setup window.
2. *Note:* The first time you upload data, enter your privacy password.
3. Enter your Realize Language account email address and Realize Language account password.
4. Tap the **Current Person** field and select the person for whom you want to upload data.
5. Tap **Upload Now**. “File successfully updated” will appear.
6. Tap **Save**. By tapping **Save**, your Realize Language account email address and Realize Language account password will be retained in the Realize Language Setup window. For future uploads, all you need to do is select the person from the Current Person list.
7. When the data has uploaded successfully, return to the Settings menu and use **Clear Log** to clear the person’s data. Then you can start collecting new data for that person.

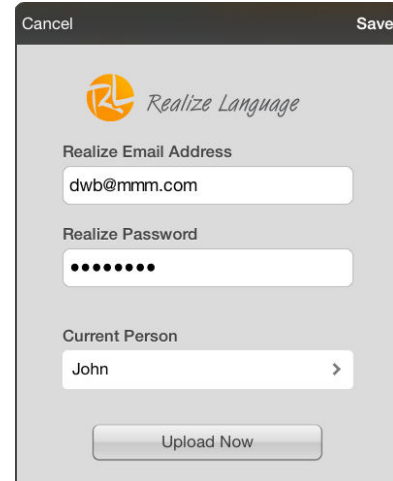

Dedicated Devices: Manually Uploading Data for Analysis

Upload data collected for a person to the Realize Language website for analysis.

Important! Before starting this procedure, see “Connecting to a Computer for the First Time” on page 112.

1. Connect the device to your computer.
2. Open iTunes on the computer.
3. In iTunes on the computer, tap on the device and go to the Apps section.
4. Scroll down until you see TouchChat in the File Sharing area.
5. Highlight the **logFile.txt** file that you are uploading.
6. Click **Save To** on the bottom right. A Windows save box will open. Select the folder in which you want the file saved.
7. Log onto the Realize Language website.
8. Select **Upload Data File** and then **Select a File to Upload**.
9. Select the file and click **Upload**.

Clearing Usage Data

To clear usage data for the current person:

1. Under Data Logging, tap the **Clear** button.
2. The Privacy Password prompt and keyboard will be displayed. Type your privacy password and tap **Enter**.
3. “Do you really want to Clear Log?” will be displayed. Choose **Yes** to clear the data log.
4. “Clear Log Completed” will be displayed. Tap **Okay** to close the message.

Changing or Removing Your Privacy Password

By default, each time you save data to a file, you enter a password. Entering a password helps ensure privacy—only you will be able to view the data. You can change this privacy password as often as you want, or you can eliminate the need for a privacy password.

To change your privacy password:

1. Under Data Logging, tap the password box located to the right of **Privacy Password**. A Privacy Password prompt and keyboard will be displayed.

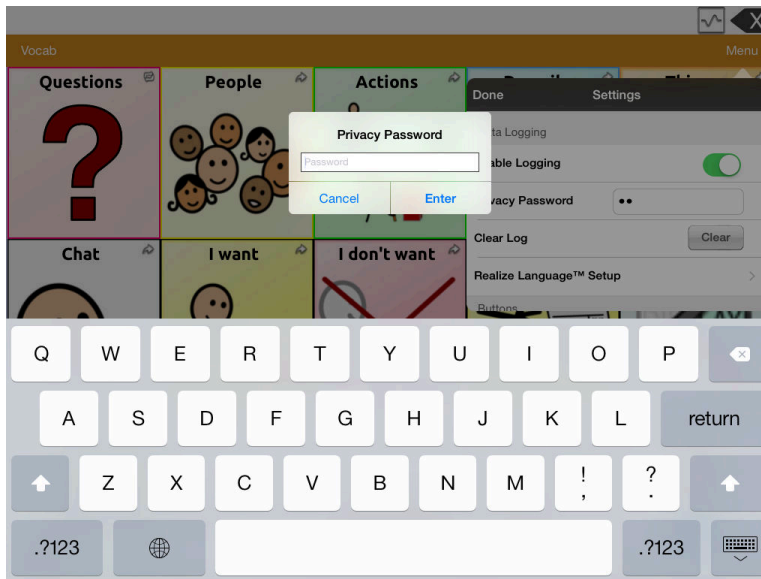

2. Type your old privacy password and tap **Enter**. A cursor will appear in the password box.
3. Use the backspace key  to clear the Privacy Password field.
4. Type your new password and tap **Done**.
5. The Confirm New Privacy Password prompt will be displayed. Type your new password again and tap **Enter**.
6. “New Password Set” will be displayed. Tap **OK** to close the message.

To remove your privacy password:

If you prefer not to enter a password each time you save data to a file, use this procedure. Keep in mind, however, that you will also lose the privacy protection a password provides.

1. Under Data Logging, tap the password box located to the right of **Privacy Password**. A Privacy Password prompt and keyboard will be displayed.
2. Type your old privacy password and tap **Enter**. A cursor will appear in the password box.
3. Use the backspace key  to clear the Privacy Password field and tap **Done**.
4. “Privacy Password Cleared” will be displayed. Tap **OK** to close the message.

Adding a Webhook Event to a Button

Do you know about webhooks and would you like to use them with your device? Here's how TouchChat supports them. *Please note that this section requires a basic understanding of webhooks and programming skills.*

Important! You must be connected to Wi-Fi to use webhooks.

Terms Used in This Section

Term	Meaning
webhook	A webhook is an event that triggers an action.
Webhook service/provider	A webhook service is a web application for retrieving and storing data from a certain event.
Webhook event	<p>A webhook event is a web request via a URL that can contain additional information needed by the webhook service/provider.</p> <p>There are two parts to a webhook event: (1) the URL and (2) the payload in JSON format. The event is the piece that TouchChat sends.</p> <p><i>Event example:</i> Create a document</p>
URL	A URL is a website address. For webhooks, a URL is the address sent to trigger an event. Webhooks use the http protocol to communicate with the webhook service/provider.
Payload	<p>Additional instructions can be sent with the URL to perform the event. These additional instructions are referred to as a payload.</p> <p><i>Note:</i> Not all events need a payload.</p> <p><i>Payload examples:</i> Add content to your document (see “webhook event” above); format the content</p> <p>The webhook service/provider defines the payload. Here's what a small portion of a payload looks like when it's delivered to a webhook service:</p> <pre>{ "event_id": "LtWXD3crgy", "event_type": "form_response", "form_response": { "form_id": "IT4Z3j", "token": "a3a12ec67a1365927098a606107fac15", "submitted_at": "2018-01-18T18:17:02Z",</pre>
JSON	Webhooks must deliver responses (payloads) in JSON format, a language used by programmers. TouchChat provides an interface for these responses. The example under “payload” above is in JSON format.

Adding a Webhook Event

You can create as many webhook buttons as you want, but you can only specify one URL for each button.

Examples of webhook events: send the latest weather report to your device; trigger a payment; send an alert when something happens; turn on a light; open a door; set a thermostat; operate a smart home device

Note: You can simplify programming webhooks by using ChatEditor, especially copying and pasting URLs and entering data in JSON format.

1. Go to the page on which you want the webhook button and tap **Menu**.

2. Tap **Edit Page**. The page is now in Edit Mode.

3. Either tap or touch and hold the button you want to modify. The Edit Button menu opens.

4. Tap **Edit This Button**. A window opens that will allow you to modify the button.

5. Enter a button label and select or import an image.

6. Scroll down to the Button Actions section.

7. Tap **Add** to open a list of actions.

8. Tap **WebHook** to open a window.

9. Tap after **https://** to insert a cursor and open a keyboard.

10. Enter the URL for the webhook event. This can be copied from the webhook service/provider site.

11. If your event requires a payload, tap in the **JSON** field to insert a cursor and enter the data in JSON format that you want to send from the button.

12. To test the webhook, tap **Test Webhook**.

13. When you finish, tap **Done**. The webhook URL will appear in the Button Actions section.

14. Tap **Save**.

15. Make sure you have an active Wi-Fi connection and choose the button you created.



The screenshot shows a mobile application dialog box for configuring a webhook. At the top, there are 'Cancel' and 'Done' buttons. Below them, there are two main sections: 'WebHook URL' and 'WebHook JSON'. The 'WebHook URL' section has a text input field containing 'https://'. The 'WebHook JSON' section has a text input field containing '{ }'. At the bottom of the dialog, there is a 'Test Webhook' button.

Non-Dedicated Devices: Viewing TouchChat and Another App Side-by-Side

On a non-dedicated device, iOS Split View allows you to view two apps side-by-side at the same time. Not all apps support this feature. Split View should function by default. If Split View does not function by default, open the iOS Settings, select **Home Screen & Dock**, select **Multitasking**, and turn on **Allow Multiple Apps**.

Important! If you are using TouchChat on a dedicated device, you will not be able to use Split View.

1. On your device, open the TouchChat app.
2. Swipe up from the bottom of the screen to display the list of your recently used apps.



3. On the list, touch and hold the icon for the app you want to view with TouchChat and then drag it off the dock to the left or right edge of the screen. The apps will appear side-by-side.

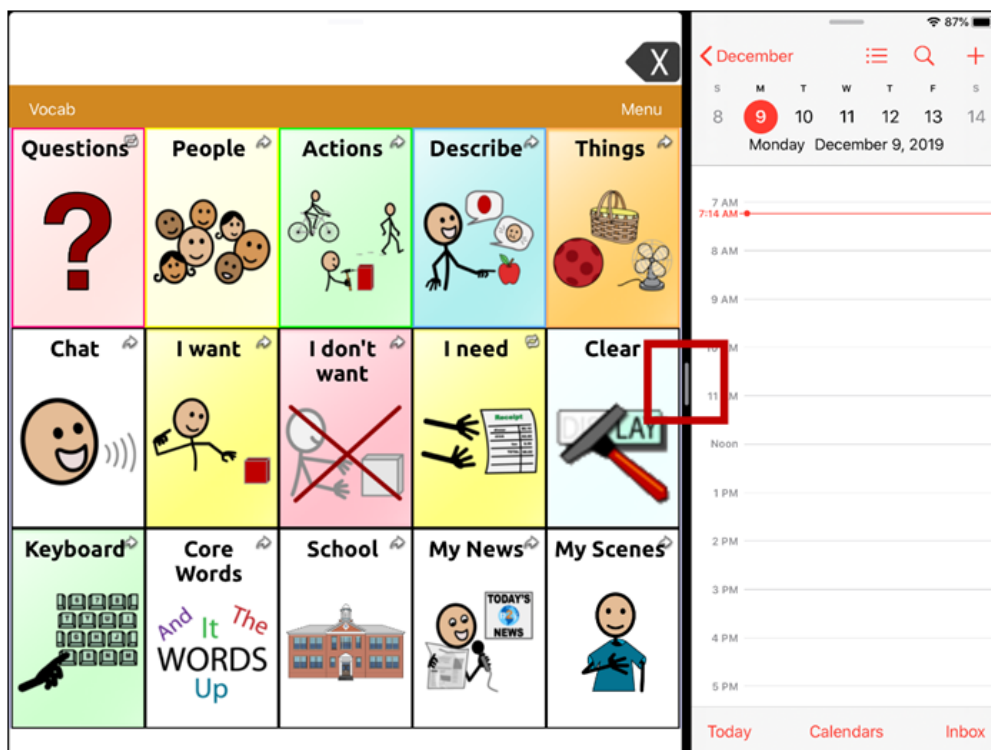

Note: To adjust the relative size of each app, drag the app divider to the left or right.



Telephony: Using the TouchChat App to Make Phone Calls

Important!

- You must be using the TouchChat app on a non-dedicated device. If you are using a dedicated device, you will not be able to use the phone functionality.
- You must have version 2.23 or later of the TouchChat app, and your device must be running iOS 13 or later.
- You and each person you call must have a FaceTime® account.

To select or change your phone voice:

During a phone call, your phone voice will be different from your usual device voice.

1. In TouchChat Settings, in the Speech section, select **Phone/FaceTime Voice** to open a list of available voices. The voice currently selected displays a checkmark.
2. To change the voice, select the  icon to hear how a voice sounds. Listen to several voices if necessary.
3. When you find the voice you want, select the  icon to download and install it.

To make a phone call:

1. On your device, open the TouchChat app.
2. Swipe up from the bottom of the screen to display the list of your recently used apps.



Hint: If you haven't used the FaceTime app recently, the icon will not appear on the list. Open FaceTime and then close it. The icon will then appear on the list.

3. On the list, touch and hold the FaceTime app icon and then drag it off the dock to the left or right edge of the screen. TouchChat and FaceTime will appear side-by-side.

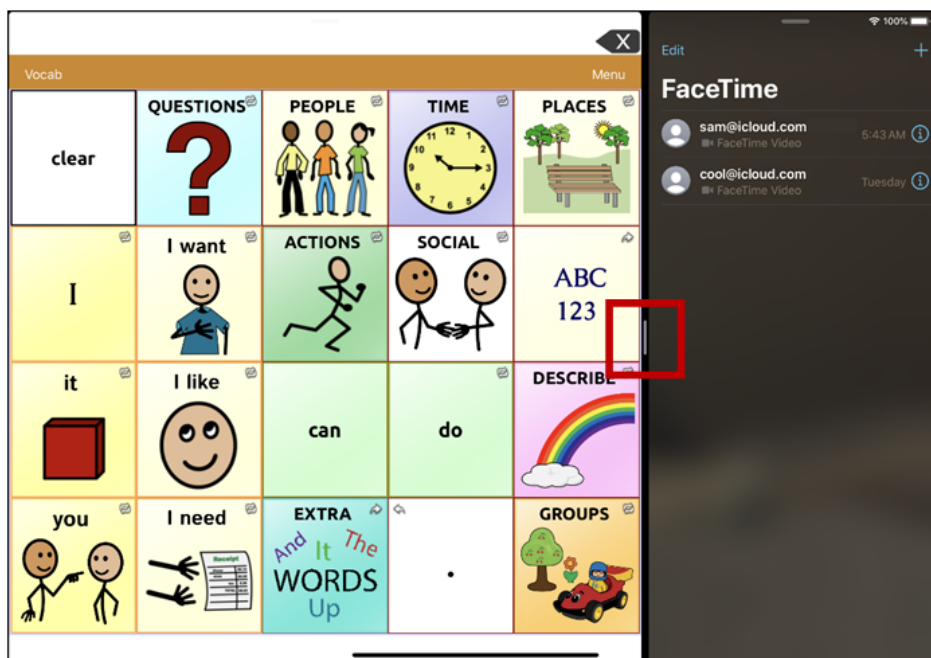

Note: To adjust the relative size of each app, drag the app divider to the left or right.

4. From the FaceTime app, select the person you want to call.
5. When the person you are calling answers, use the TouchChat app to start speaking.
Note: During the call, TouchChat will switch from your usual device voice to the Phone/FaceTime voice you selected. When you end the call, TouchChat will switch back to your usual device voice.
6. To close FaceTime and Split View when you end the call, drag the app divider over FaceTime.

Note: If you want to see words highlighted in the SDB as they are spoken during a telephony call, see “Highlighting Words as They are Spoken during a Telephony Call” on page 89.

Connecting to a Computer for the First Time

When you connect your TouchChat Express to a computer for the first time to perform an update or backup, a message prompts you to “trust” the computer. You must tap **Trust** to proceed. On a dedicated TouchChat Express device, this Trust message is hidden behind the application screen. Use the following procedure to access the message.

Important! You will need to repeat this procedure the first time you connect your device to a different computer.

1. On the computer, launch iTunes®.
2. Connect your USB cable to the device and the computer.
3. On the TouchChat Express device, simultaneously hold down the *Home key* and the *device power button* until the device screen turns black. This will take approximately 15-30 seconds.
4. Release the Home key and power button. The device will restart. When the device has restarted, the Trust message will appear.

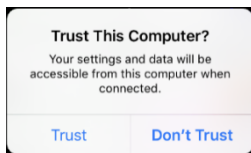

5. Tap **Trust**.
6. On the computer, a message similar to the following will appear:

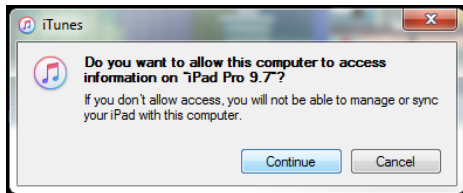

7. Click **Continue**. A progress bar will be displayed.
8. When the progress bar disappears, unplug the USB cable from the device and immediately plug it back in. This will refresh the device.
9. You are now ready to proceed with your update or backup.

Non-Dedicated Devices: Updating the TouchChat Application Software

We are required to ship devices locked and with access to only communication software, when required by a funding source. With Android™ and Microsoft® Windows® tablets, we are able to provide access to Wi-Fi that allows us to update the communication software without providing a way to exit the communication software, but that is not possible with iPad software at this time. If this capability becomes available, we will certainly work with our software teams to make this happen. Until then, you can contact Saltillo Sales to unlock the system for \$25, update the software through Wi-Fi, and lock it again/put it into Guided Access.

It's possible our competitors have different interpretations of the regulations than we do, but we cannot change our policies to accommodate their interpretations if they are different from what we believe to be true.

Updating TouchChat using the App Store® Icon

When an update is available, the App Store icon will appear with a number on the right-hand corner of the icon.

Important! Wi-Fi must be turned on.

1. Tap the App Store icon.
2. Tap **Updates** on the bottom right of the screen.
3. TouchChat will be listed under Updates.
4. Tap **Update** to the right of TouchChat.
5. Enter the Apple ID that you used to purchase TouchChat previously. The update will start downloading.

Updating TouchChat using iTunes

If you have iTunes version 12.6 or older, you can update TouchChat with the device connected to a computer running iTunes. If you have iTunes version 12.7 or newer, you must use the procedure shown above under "Updating TouchChat using the App Store Icon".

Important! If you have a dedicated device, do **not** update iTunes to version 12.7 or newer. If you do, you will not be able to update TouchChat.

1. Connect the device to the computer.
2. Launch iTunes on the computer.
3. Go to the Apps section of iTunes.
4. Scroll to the Updates section and locate the option "Check for Updates" in the bottom right corner of the screen.

Note: The location of the Updates option depends on the version of iTunes you are using.

5. Enter the Apple ID that you used to purchase TouchChat previously.
6. The update will start downloading.

Updating the Device Software

When an iPad software update is available, you can perform the update wirelessly or, if you cannot update wirelessly, by using iTunes.

Updating Your iPad Wirelessly

1. Connect to the Internet with Wi-Fi.
2. Choose **Settings > General > Software Update**. The Software Update screen will be displayed.
3. Tap **Download and Install**.

Updating Your iPad using iTunes

With the latest version of iTunes installed on your computer,

1. Connect the device to the computer.
2. Open iTunes and select your device.
3. Click **Summary** and then click **Check for Update**.
4. Click **Download and Update**.

Non-Dedicated Devices: Backing up Vocabulary Files

Backing up a Customized Vocabulary File using iTunes

It's a good idea to keep copies of all custom files on a computer for safekeeping. We suggest always using a wired connection to a computer to copy files consistently.

1. Connect the device to the computer.
2. Open iTunes on the computer.
3. In TouchChat, select **Vocab** and **Choose New Vocab**.
4. Select **Menu, Import/Export Vocab, and Export to iTunes**.
5. From the menu that opens, select the vocabulary file you want to export and select **Save**.
6. In iTunes on the computer, click the small device icon in the upper left portion of the window.

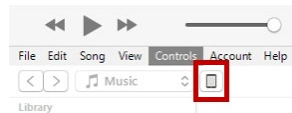

7. In the window that opens, click **File Sharing** on the left.
8. In the Apps column, select the **TouchChat** app.
9. From the column under **TouchChat Documents**, select the vocabulary file you are exporting.
10. Click **Save** on the bottom right. A Save window will open.
11. Navigate to the folder in which you want to save the file and click **Select Folder**.
12. Click **Done** and exit from iTunes.

Backing up a Customized Vocabulary File using iShare

Important! Before starting this procedure, make sure the device is connected to the Internet. On the device, go to **Settings** and then **Wi-Fi**.

To use iShare, you must have an iShare account.

1. In TouchChat, select **Vocab** and **Choose New Vocab**.
2. Select **Menu** and **iShare Service**.
3. Select **Login to iShare**.

Note: If you don't have an iShare account, you can receive a free 365-day trial by selecting **Register for iShare**. Enter your name, create and confirm a password, and select **Register**.

4. Enter your iShare account e-mail address and password.
5. Select **Login** and select **Okay**.
6. Choose the folder you want to use.
7. Select **+** and then select the file you want to save.
8. Enter a name, description, keywords, and file revision.
9. Select **Upload** and select **Okay**.

To download a previously saved file: Navigate to the folder, select the file, and select **Download**.

To delete a previously saved file: Navigate to the folder, select the file, select **Delete**, and select **Yes** to confirm.

Backing up a Customized Vocabulary File using AirDrop®, Google Drive™, or Email

1. In TouchChat, select **Vocab** and **Choose New Vocab**.
2. Select **Menu** and **Import/Export Vocab**.
3. Select **Export and Share**.
4. Select the vocabulary file you want to export.
5. Select **Done** and select the method you want to use to share the file.
 - **AirDrop:** Bluetooth and Wi-Fi must be active. You will see the nearby devices that have AirDrop on and can accept your file. Choose the device you want.
 - **Google Drive:** Requires Google Drive set up on the device and access to Wi-Fi.
 - **Email:** Requires an email account set up on the device and access to Wi-Fi.

Backing up a Customized Vocabulary File using Dropbox®

Note: You must have a Dropbox account. Wi-Fi must be active or you must have the Dropbox app on your device.

1. In TouchChat, select **Vocab** and **Choose New Vocab**.
2. Select **Menu** and **Import/Export Vocab**.
3. Select **Dropbox**.
4. Select **Export to Dropbox**.
5. Sign in to **Dropbox**.
6. Select the vocabulary file you want to export.
7. Select **Upload**. When “Upload Complete” appears, select **Okay**.

Backing up and Restoring Device Files

Important! These procedures explain how to back up and restore device files only. They do not apply to TouchChat vocabulary files.

Backing up the Device

1. Open iTunes on the computer.
2. Connect your device to the computer using a USB cable.
3. In iTunes, the device will appear on the left side.
4. Right-click on the device and choose **Back Up**.
5. iTunes will start to back up the device.

Restoring the Device















1. Open iTunes on the computer.
2. Connect your device to the computer using a USB cable.
3. In iTunes, the device will appear on the left side.
4. Right-click on the device and choose **Restore from Backup**.
5. iTunes will then prompt you to select the backup. Choose the one that is the most recent sync, to ensure having the current versions.
6. iTunes will start restoring the device from the backup.

Non-Dedicated Devices: Using iPad Features

Identifying iPad Status Icons

The status bar is located at the top of the iPad screen. These icons provide the time, battery status, and information about connectivity and operations currently running.

Note: You can hide the status bar when using the TouchChat app. In TouchChat, choose **Menu > Settings**. Under Page Size, turn **Status Bar** off.

Status Icon	Description
 Activity	A third-party app is using a network or generating some other activity.
 Airplane Mode	Airplane Mode is turned on. In this mode, only non-wireless features are available. You cannot access the Internet or use Bluetooth devices.
 Alarm	An alarm is set.
 Battery	Shows the battery level or charging status.
 Bluetooth	<i>Blue or White icon:</i> Bluetooth is on and paired with a device such as a headset or keyboard. <i>Gray icon:</i> Bluetooth is on and paired with a device that is out of range or turned off. <i>No icon:</i> Bluetooth is not paired with a device.
 Bluetooth battery	Shows the battery level of a supported paired Bluetooth device.
 Do Not Disturb	Do Not Disturb is turned on. FaceTime® calls and alerts will not sound or light up the screen.
 Location Services	A location-based app is gathering and using data indicating the iPad's location.
 Lock	The iPad is locked. The display and touch capability are turned off.
 Orientation Lock	Screen orientation is locked.
 Personal Hotspot	The iPad is sharing its Internet connection with other iPad devices.
 Syncing	iPad is syncing with iTunes.
 VPN	The iPad is connected to a network using a VPN (virtual private network).
 Wi-Fi	The iPad has an active Wi-Fi connection. More bars indicate a stronger connection.

Using Control Center

Control Center provides quick access to the iPad controls. Controls vary by iPad software version and are customizable.

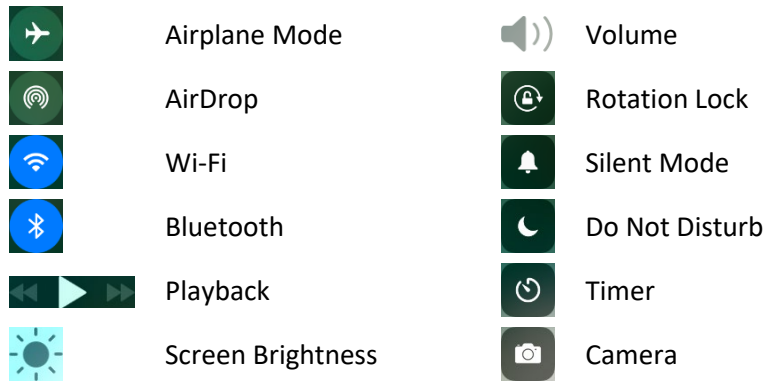

To open Control Center:

To open Control Center, swipe up from the bottom edge of any screen.

To close Control Center:

To close Control Center, use any of the following methods:

- Tap the **Close** icon
- Swipe down
- Tap anywhere on the screen above Control Center
- Press the **Home** button

To prevent access to Control Center:

To prevent the user from accessing Control Center, do the following:

1. Choose **Settings > Control Center**.
2. Turn off Access on Lock Screen or Access Within Apps or both.

Adjusting Screen Brightness

Dim the screen to extend battery life, or use Auto-Brightness. *Note:* You can also adjust screen brightness in Control Center.

1. Choose **Settings > Display & Brightness**.
2. Drag the slider.
3. If Auto-Brightness is turned on, the iPad adjusts the screen brightness for current light conditions using the built-in ambient light sensor.

Using Accessibility Features

You can turn on accessibility features individually and/or create a shortcut to a specific group of features.

Turning on Accessibility Features

To turn on one or more accessibility features individually, choose **Settings > Accessibility**. Accessibility features will be listed by category. Tap a feature to turn it on, or tap a feature and choose the option you want.

Setting up an Accessibility Shortcut

As an alternative to selecting individual accessibility features, you can create a shortcut to a specific group of accessibility features.

1. Choose **Settings > Accessibility** and select **Accessibility Shortcut** under “General”. Accessibility features will be listed.

Note: If you already turned on Guided Access, Guided Access will be listed first and display a checkmark. See the next section, “Setting up and Using Guided Access”.

2. Tap each feature you want to use. A checkmark will be displayed for each selected feature.

Setting up and Using Guided Access

Guided Access® helps the user stay focused on a task by dedicating the iPad to a single app and allowing you to control which app features are available. Use Guided Access to: Temporarily restrict the iPad to a particular app; disable areas of the screen that do not apply to a task, or areas in which an accidental gesture might be distracting; limit how long the user can use an app; or disable iPad device buttons.

Turning Guided Access On

Choose **Settings** > **Accessibility** and select **Guided Access** under “General”. Then turn Guided Access on.

Configuring Guided Access Settings

When you turn Guided Access on, additional options appear: Passcode Settings, Time Limits, and Accessibility Shortcut.

Setting a Passcode

Passcode Settings allows you to set a passcode to prevent the user from leaving a Guided Access session.

1. Tap **Passcode Settings**.
2. Tap **Set Guided Access Passcode**. The Set Passcode window opens.
3. Tap numbers to set your passcode.

Note: This setting also turns on Touch ID, providing an alternative way to end a Guided Access session.

Setting Sounds

Time Limits allows you to set an alert tone or ring tone or have remaining Guided Access time spoken.

1. Tap **Time Limits**.
2. Tap **Sound**. The Alert Tones and Ringtones lists are displayed.
3. Tap a tone to hear how it sounds.
4. Keep tapping tones until you hear the one you want.

Note: To turn off *both* alert tones and ringtones, tap **None (Default)**.

To have the remaining Guided Access time spoken before time ends:

1. Tap **Time Limits**.
2. Turn on **Speak**.

Allowing Accessibility Shortcuts

If you set up a shortcut to a group of accessibility features (see “Setting up an Accessibility Shortcut” on page 120), you can make those accessibility features available during a Guided Access session.

1. Choose **Settings** > **Accessibility** and select **Guided Access** under “General”.
2. Turn on **Accessibility Shortcut**.

With Accessibility Shortcut turned on, when you press the **Home** button quickly three times while Guided Access is enabled, a menu will list the accessibility features you chose. Simply tap a shortcut to turn on the feature.

Setting up and Starting a Guided Access Session

After turning on Guided Access, do the following:

1. Open TouchChat or any other app you want the user to work with.
2. Press the **Home** button quickly three times. The Guided Access options will be displayed.
3. Adjust settings for the session.

To ...	Do this:
Disable app controls and areas of the app screen	Draw a circle or rectangle around any part of the screen you want to disable. Drag the mask into position or use the handles to adjust its size.
Turn on the Sleep/Wake button	Tap Options below “Hardware Buttons” and turn on Sleep/Wake Button . When this button is turned on, the iPad will sleep after a period of time, and the device lock button can be pressed to lock the device immediately. This setting conserves battery power. <i>Note:</i> When Guided Access is turned on, Auto-Lock time is not used, which can keep the device active and drain the battery.
Turn on the Volume buttons	Tap Options below “Hardware Buttons” and turn on Volume Buttons .
Prevent the iPad from responding to motion	Tap Options below “Hardware Buttons” and turn off Motion . When motion is turned off, the iPad will not switch between portrait and landscape orientations when the device is rotated nor will it respond to any other motions.
Prevent typing	Tap Options below “Hardware Buttons” and turn off Keyboards .
Ignore screen touches	Turn off Touch .
Set a session time limit	Tap Options below “Time Limit” and tap Time Limit on the pop-up menu to activate the settings. Then scroll through the numbers and tap the hour and minute numbers you want.

4. Tap **Start** in the upper right corner of the screen.

Ending a Guided Access Session

1. Press the **Home** button quickly three times.
2. Enter your Guided Access passcode.

Note: Alternatively, use Touch ID (which was enabled when you set the passcode). Touch ID uses the sensor in the Home button instead of your passcode.

Syncing with iTunes

Syncing with iTunes copies information from your computer to the device and from the device to your computer. You can sync by connecting the device to your computer. On a non-dedicated device, you can set up iTunes to sync wirelessly using Wi-Fi.

Setting up Wireless Syncing

Connect the iPad to your computer. In iTunes on your computer, select your iPad, click **Summary > Sync with this iPad over Wi-Fi**. If Wi-Fi syncing is turned on, the iPad syncs when (a) it is connected to a power source, (b) both the iPad and your computer are turned on and connected to the same wireless network, or (c) iTunes is open on your computer.

Syncing with iTunes on your Computer

Connect the device to your computer, select it in iTunes, and then set options in the different panes. If the device does not appear in iTunes, make sure you are using the latest version of iTunes, verify that the cable is correctly connected, and then try restarting your computer.

In the Summary pane, you can set iTunes to sync the device automatically when it is attached to your computer. To temporarily prevent syncing when you attach the device, hold down Command and Option (Mac®) or Shift and Control (PC) until you see the device appear in the iTunes window.

To sync using the Info, Music, or Photos panes:

Pane	Description
Info pane	Click Advanced to select options that let you replace the information on the iPad with the information from your computer during the next sync.
Music pane	Sync music using your playlists.
Photos pane	Sync photos and videos from a supported app or folder on your computer.

Encrypting Backup Information

To encrypt the information stored on your computer when iTunes makes a backup, select **Encrypt local backup** in the Summary pane. Encrypted backups are indicated by a lock icon , and a password is required to restore the backup.

If you do not select this option, other passwords (such as those for mail accounts) are not included in the backup and you will need to reenter them if you use the backup to restore iPad.

Note: If you use iCloud to store your contacts, calendars, and bookmarks, do *not* sync them to the iPad using iTunes. If you turn on iCloud Photo Library, you cannot use iTunes to sync photos and videos to the iPad.

Setting up and Using iPad Switch Scanning

As an alternative to directly choosing each button on the screen, single-switch and two-switch scanning are available.

Enabling Scanning

Press the device's **Home** button. Then choose **Settings > Accessibility > Switch Control**. Turn Switch Control **on**.

Defining the Switches

You can either use an external switch that is plugged into device switch jack A or B or you have the option to use the screen as a switch.

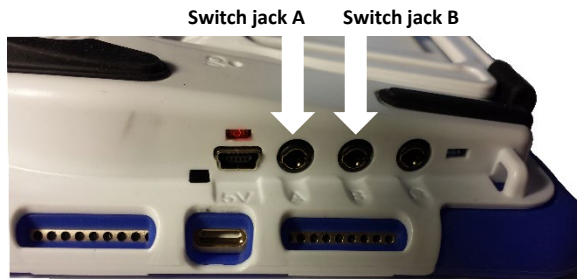

TouchChat Express 8 used as example

To use an external switch:

1. Plug the switch into either switch jack A or B. If you are using two switches, plug a switch into each.
2. Choose **Settings > Accessibility > Switch Control**.
3. Choose **Switches > Add New Switch > External**.
4. Press the external switch.
5. Name the switch.
6. Choose the switch action to perform.
 - If you are using just one switch, choose **Select Item**.
 - If you are using a second switch, choose **Add New Switch**. For the switch action, you could choose **Move To Next Item**.
 - If you need another option, you can use the screen as a switch.

After setting up your switch:

Press the device's **Home** button. Then choose **Settings > Accessibility > Switch Control**. Turn Switch Control **off** and then back **on**.

Setting the Scanning Style

You can choose to have the system automatically scan or to step to each location. With step-scanning, a switch must be pressed to move the scan to each button, one at a time. With auto-scanning, a switch must be pressed to start the scan and the system will continue to scan until the switch is pressed again.

To set the scanning style, choose **Settings > Accessibility > Switch Control > Scanning Style**. Three scanning styles are available: Auto Scanning, Manual Scanning, and Single Switch Step Scanning.

Note: Long Press is not currently available within the TouchChat app.

Auto Scanning

Auto Scanning moves from item to item automatically after a specified duration. When Auto Scanning is selected, these timing settings are available.

Setting	Description
Auto Scanning Time	Determines how fast scanning performs with Auto Scanning turned on
Pause on First Item	Determines how long Auto Scanning will wait after input
Loops	Determines how many times each item is visited prior to stopping the scan
Move Repeat	Determines how long before “Move to Next/Previous Item” is repeated while a switch remains pressed

Manual Scanning

Manual Scanning allows the user to step from item to item by activating one switch and then select an item by activating a second switch. When Manual Scanning is selected, these timing settings are available.

Setting	Description
Auto Hide	Determines how long it takes for the scanning interface to disappear due to inactivity
Move Repeat	Determines how long before “Move to Next/Previous Item” is repeated while a switch remains pressed

Single Switch Step Scanning

Single Switch Step Scanning allows the user to step from item to item by activating the switch. When the user reaches a desired item, he or she stops activating the switch for a specified dwell time. The item is then selected automatically. When Single Switch Step Scanning is selected, these timing settings are available.

Setting	Description
Dwell Time	Determines the duration before the user can select an item.
Auto Hide	Determines how long it takes for the scanning interface to disappear due to inactivity
Move Repeat	Determines how long before “Move to Next/Previous Item” is repeated while a switch remains pressed

Additional Timing Options

These timing options are available under “Switch Stabilization”.

Setting	Description
Hold Duration	This option sets the duration the switch must be held before a press is recognized. This duration must be less than the Auto Tap time so that a double input press can be used.
Ignore Repeat	This option sets the duration in which multiple presses of input are treated as a single input. This duration must be less than the Auto Tap time so that a double input press can be used.

Configuring Additional Scan Settings

Tap Behavior

By default, when the user selects an item, a pop-up menu appears, providing options for interacting with that item (Tap, Scroll, etc.). Two alternative behaviors are available. To access these alternatives, choose **Settings > Accessibility > Switch Control > Tap Behavior**.

Setting	Description
Auto Tap	Turning Auto Tap on hides the pop-up menu, unless the user activated the switch within a specified duration.
Always Tap	Turning Always Tap on displays the pop-up menu at the end of the scan. This allows the user to select an item with a single switch activation and scan to the pop-up menu to access it. The pop-up menu appears in the middle of the screen.

Always Tap Keyboard Keys

When Always Tap Keyboard Keys is turned on, keyboard keys will always be selected with a single switch activation instead of displaying a pop-up menu immediately when selected.

Scan Audio

Scroll to the “Audio” section and turn **Sound Effects** and **Speech** on or off.

Menu Scanning

To include all menus in scans, leave **Included Menu Items** set at **All**.

To exclude one or more menus from scanning, tap **Included Menu Items** to open a list of menus. Then tap the name of each menu you want to exclude to remove the checkmark.

Scanning Cursor Size and Color

The “cursor” is the highlight that appears around the scanned button area. To change the cursor size and color, scroll to the “Visual” section.

To double the thickness of the highlight, turn **Large Cursor** on. To change the color of the cursor, tap **Cursor Color** to open a list of color options. Blue, Red, Green, Yellow, and Orange are listed, and a checkmark appears after the color currently selected. Tap the color you prefer.

Pause on First Item

Pause on First Item allows you to find the next item you want to select before a scan resumes. When this setting is turned on, a scan will pause on the first item for the number of seconds you specify and will pause again after the item has been selected and the scan resumes.

Setting Loops

When Auto Scanning is turned on, the Loops setting determines the number of times a scan will go through all items and start over automatically. When the set number of loops finishes, the scan will stop. You can start the scan again by activating the switch.

Sound Effects

When Sound Effects is turned on, a clicking sound is activated as a scan moves from one item to another.

Speech

When Speech is turned on, an item is spoken as well as highlighted when a scan selects it.

Menu Items

When Menu Items is turned on, you can select what items show up in the pop-up menu during a scan.

Group Items

When Group Items is turned on, a scan display items on the screen in groups instead of individually. This allows you to scan between groups, select a group, and then select an item within the group.

Cursor Color

Use the Cursor Color setting to change the color of the scan border to make it easier to see as it moves.

Long Press

Note: Long Press is not currently available within the iPad software.

Dwell Time

When Step Scanning is selected, Dwell Time allows you to set the number of seconds the user must wait for an item to be selected on the screen automatically.

Auto Hide

When Step Scanning is selected, Auto Hide will make the scanning cursor disappear if the user does not activate the switch within a predetermined number of seconds. Activating the switch will redisplay the cursor.

Using Keyboards

Your iPad allows you to use one or more on-screen keyboards or an Apple Wireless Keyboard.

Using On-screen Keyboards

You can change a keyboard's text entry options and layout; split and move a keyboard; or add keyboards and switch between them.





Setting Text Entry Options

Choose **Settings > General > Keyboard**. Then turn the options under "All Keyboards" on or off.

Changing the Keyboard Layout

1. Choose **Settings > General > Keyboard > Keyboards**.
2. Select a keyboard.
3. Choose a keyboard layout.

Using a Split Keyboard



1. Choose **Settings > General > Keyboard** and turn **Split Keyboard** on or off.
2. With an on-screen keyboard displayed, touch and hold the Keyboard key  and slide your finger to **Split** and release. The keyboard will split in half and move to the middle of the screen.
3. You can merge and move the keyboard as follows:
 - To return to the default keyboard and leave it in the middle of the screen, touch and hold  and slide your finger to **Merge** and release.
 - To return to the default keyboard, docked at the bottom of the screen, touch and hold  and slide your finger to **Dock and Merge** and release.
 - To move the default keyboard to the middle of the screen, touch and hold  and slide your finger to **Undock** and release.
 - To return to the default keyboard to the bottom of the screen, touch and hold  and slide your finger to **Dock** and release.

Adding a Keyboard for Another Language

Choose **Settings > General > Keyboard > Keyboards > Add New Keyboard**. Then select a keyboard.

Switching or Hiding Keyboards

If you have not added any keyboards, tap  to switch to the emoji keyboard.

If you have added keyboards, tap  to switch to the one you used previously. Continue tapping to access other available keyboards, or touch and hold , and then slide to choose a different keyboard.

To hide the onscreen keyboard, tap the Keyboard key .

Using the Apple Wireless Keyboard

You can use the Apple Wireless Keyboard to enter text. The keyboard connects via Bluetooth, so you must first pair it with iPad.

Note: The Apple Wireless Keyboard may not support keyboard features that are on your device. For example, it does not anticipate your next word or automatically correct misspelled words.

To pair an Apple Wireless Keyboard with the iPad:

1. Turn on the keyboard.
2. Choose **Settings** > **Bluetooth** and turn on Bluetooth.
3. Tap the keyboard when it is displayed in the Devices list.

Once the keyboard is paired, the keyboard reconnects to the iPad whenever it is in range. When the Apple Wireless Keyboard is connected, the onscreen keyboard does not appear.

To unpair a wireless keyboard:

1. Choose **Settings** > **Bluetooth**.
2. Tap next to the keyboard name.
3. Tap **Forget this Device**.

Using an External Keyboard with TouchChat

If you need to use an external keyboard with TouchChat, TouchChat needs to give a command to replace the TouchChat keyboard with a system keyboard. If an external keyboard is not attached, the iPad keyboard will appear on the screen. The command to use the system keyboard needs to be stored to a TouchChat button for turning on and off.

1. Go to the page where the button will be created.
2. Tap **Menu** and tap **Edit Page**.
3. Tap the button where the system keyboard button will be located.
4. Select **Edit This Button**.
5. Add a button label and, if needed, an image.
6. Modify the button style, if necessary.
7. In the Button Actions section, tap **Add**.
8. Tap **System Keyboard**.
9. Tap **Save**.

Entering and Modifying Text

Use the onscreen keyboard or an Apple Wireless Keyboard to enter text.

Typing Text



Tap a text field to open the onscreen keyboard and then tap letters. If you touch the wrong key, slide your finger to the correct key. A letter is entered when you release your finger from the key.

To ...	Do this:
End a sentence with a period and space quickly	Double-tap the space bar.
Enter uppercase text	Tap Shift to type uppercase or touch the Shift key and slide to a letter. Double-tap Shift to engage caps lock. To enter numbers, punctuation, or symbols, tap the Number key 123 or the Symbol key #+= .
Enter accented letters or other special characters	Touch and hold a key and then slide to choose one of the options.

Note: If you see a word underlined in red, tap it to see suggested corrections. If the word you want is not displayed, type the correction.

Working with Predictive Text

As you enter text, the keyboard will predict your next word. Tap a word to choose it, or accept a highlighted prediction by entering a space or punctuation mark. When you tap a suggested word, a space appears after the word. If you enter a comma, period, or other punctuation mark, the space is deleted.

To ...	Do this:
Reject a suggestion	Tap your original word, which is shown as the predictive text option with quotation marks.
Hide predictive text	Pull down the suggested words. If you want to see the suggestions again, drag the bar up.
Turn off predictive text	Touch and hold  or  , and then slide to Predictive .

Correcting Misspelled Words

Even if you turn off predictive text, the keyboard will continue to suggest corrections for misspelled words.

To ...	Do this:
Accept a correction	Enter a space or punctuation, or tap Return .
Reject a correction	Tap the “x.” If you reject the same suggestion a few times, it will no longer be suggested.

Modifying Text

To modify text, do the following:

1. Touch and hold the text to display the magnifying glass.
2. Drag to position the insertion point.
3. Tap the insertion point to display the selection options.
 - Double-tap a word to select it.
 - Drag the grab points to select more or less text.
 - In read-only documents, such as webpages, touch and hold to select a word.
4. Cut, copy, or paste over selected text.

Note: With some apps, you can also get bold, italic, or underlined text (tap B/I/U); get the definition of a word; or have the iPad suggest an alternative. You may need to tap to see all the options.

5. To justify text, select the text, and then tap the left or right arrow.
6. To undo your last change, shake the iPad and then tap **Undo**.

Using Shortcuts

A shortcut lets you enter a word or phrase by typing just a few characters. For example, type **omw** to enter “On my way!” You can also add your own shortcuts.

To create a shortcut, choose **Settings > General > Keyboard > Shortcuts**.

Hint: If you have a word or phrase you use that you do not want corrected, create a shortcut, but leave the Shortcut field blank.

Use iCloud to keep your personal dictionary up to date on your other devices. Choose **Settings > iCloud** and turn on iCloud Drive or Documents & Data.

Dictating Text

You can use the iPad to dictate text as well as type.

To turn on dictation:

1. Make sure the iPad is connected to the Internet.
2. Choose **Settings > General > Keyboard > Enable Dictation**.

To dictate text:

1. Tap the iPad keyboard.
2. Speak the words you want to dictate.
3. When you finish, tap **Done**.
4. Tap again to continue dictating.

To insert text, tap to place the insertion point first. You can also replace selected text by dictating.

To add punctuation or format text:

Say the punctuation or format. For example, “Dear Mary comma the check is in the mail exclamation mark” becomes “Dear Mary, the check is in the mail!” Punctuation and formatting commands include:

- quote ... end quote
- new paragraph
- new line
- cap—to capitalize the next word
- caps on ... caps off—to capitalize the first character of each word
- all caps—to make the next word all uppercase
- all caps on ... all caps off—to make the enclosed words all uppercase
- no caps on ... no caps off—to make the enclosed words all lowercase
- no space on ... no space off—to run a series of words together
- smiley—to insert :-)
- frowny—to insert :-(
- winky—to insert ;-)

Organizing Apps and Changing Wallpaper

You can rearrange your apps and organize them in folders. You can also change the background image used as wallpaper.

Arranging Your Apps

1. Touch and hold any app on the Home screen until it jiggles.
2. Drag the app to the position you want.
 - Drag an app to a different position on the same screen.
 - Drag an app to the edge of the screen to move it to a different Home screen.
 - Drag an app to the Dock at the bottom of the screen.
3. Press the **Home** button to save your arrangement.

Organizing Apps in Folders

You can have multiple pages of apps in a folder.

1. While arranging apps, drag one app onto another to create a folder.
2. Tap the name of the folder to rename it.
3. Drag apps to add or remove them.
4. Press the **Home** button when you finish.

Note: To delete a folder, drag all the apps out of it. The empty folder will be deleted automatically.

Creating a New Home Screen

While arranging apps, drag an app to the right edge of the last Home screen. The dots above the Dock show which of your Home screens you are viewing.

Changing the Wallpaper

Wallpaper settings allow you to set an image or photo as wallpaper for the Lock screen or Home screen. You can choose from dynamic and still images.

To change the wallpaper, choose **Settings > Wallpaper > Choose a New Wallpaper**.

When you choose an image for new wallpaper, the Perspective Zoom button determines whether your selected wallpaper is zoomed. For wallpaper you already set, go to the Wallpaper setting, then tap the image of the Lock screen or Home screen to see the Perspective Zoom button.

Restoring Your Original Apps Layout and Wallpaper

Choose **Settings > General > Reset > Reset Home Screen Layout**. The folders you created are removed, and the original wallpaper is restored.

Setting the Date and Time

You can set your iPad to retrieve the time and date automatically or you can set it manually. You also have the option to show time in 24-hour or 12-hour time.

Set Automatic Date and Time Updates

Choose **Settings** > **General** > **Date & Time**, and then turn **Set Automatically** on. If you set the iPad to update the time automatically, the iPad retrieves the correct time over the network and updates it for the time zone you are in.

Set the Date and Time Manually

Choose Settings > General > Date & Time, and then turn Set Automatically off.

Set 24-Hour or 12-Hour Time

Choose **Settings** > **General** > **Date & Time**, and then turn 24-Hour Time on or off.

Making an In-App Purchase

Saltillo provides additional voices, other language packages, unique vocabulary files, support packages, and curriculum support in the Upgrade Store. Apple provides an option for these materials to be purchased from within the TouchChat application.

To explore the Upgrade Store:

1. Enable a wireless connection.
2. Tap **Vocab** and tap **Choose New Vocab**.
3. Tap **Menu** and tap **Upgrade Store**.
4. Tap **Enter Upgrade Store**.
5. Scroll through the available items.
6. Choose the item you want and select **Buy**.
7. Log in using your iTunes account information and complete the purchase.

NCMEC First Responder Event

This free in-app download consists of TouchChat pages to support the project by The National Center for Missing and Exploited Children, entitled “How to Host a Sensory Friendly First Responder Event for Children with Autism”. None of the activities has a link to a Home page, so the Back button in TouchChat must be used to move from one activity to another. The idea is that the facilitator will set the page for a specific activity, and then the child will stay on that page. The facilitator will use the Back button to navigate back to the Home page. By design, some of the pages don’t speak. They are intended to allow the child to show, rather than tell, the facilitator how he or she is feeling.

Playing a Song from TouchChat

Audio files such as music contained in the device user's iPod® media library can be played.

1. Edit a button and tap the action **Play Library Audio**.
2. Choose the song from your music Library.
3. Give your button a label and add a picture.

Note: You will also want to include a Stop button on your page in case you need to stop the song before it is finished playing. To create a Stop button:

4. Choose the location, edit the button, add a label and icon, and tap the action **Stop Library Audio**.
5. If Speech Message remains in the Button Actions section, tap **Edit** and click the delete icon  in front of Speech Message.
6. Tap **Save** and tap **Done**.

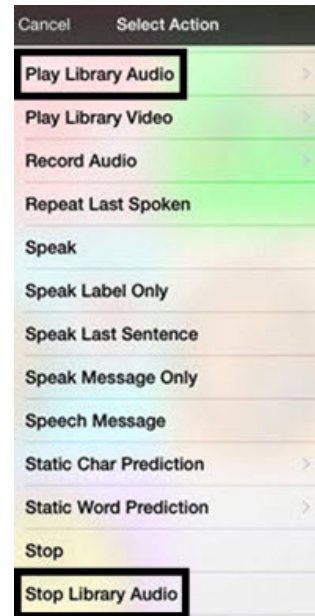

Using SocialChat

Text generated with TouchChat pages can be shared with social media, such as Facebook, Tumblr, and Twitter accounts.

1. Make sure a wireless network connection is established and accounts for the preferred social network are set up.
2. Go into the TouchChat app; generate the text you wish to post to the social network.
3. Press and hold on the Speech Display Bar (SDB) until the Share and Copy options appear.
4. Tap **Share** and tap the social network you wish to send the text to.

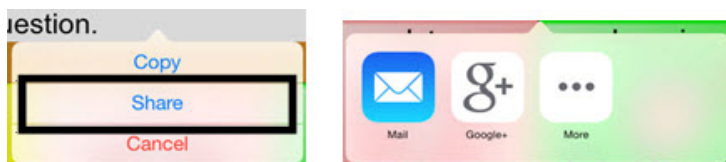

Setting up a Button to Play a YouTube™ Video

Note: You must have an active Wi-Fi connection.

1. On your device, select the YouTube video you want.
2. Tap the **Share** icon and then tap the **Copy Link** icon. A “Copied” message should appear.

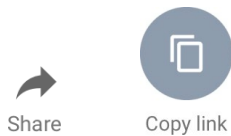

Note: If you have an older iPad software version, tap the Share link and choose **Copy**.

3. In TouchChat, display the page that has the button you want to use to play the YouTube video.
4. Choose **Menu > Edit Page**.
5. Tap the button you want to use and choose **Edit This Button**.
6. Give the button a label and scroll down to the Button Actions section.
7. Select the existing action to open the Select Actions list.
8. Select the action **Play Video**. The Video Type window will display two options.
9. Select **YouTube Video**. The YouTube window will display a Video Link field.
10. Press and hold on the Video Link field. A small Paste prompt will appear.

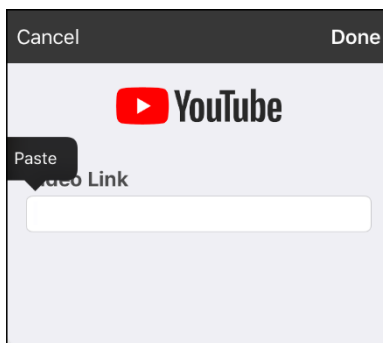

11. Tap the **Paste** prompt. The link you copied in step 2 will be pasted into the field.
12. Select **Done**. Play Video will be displayed under Button Actions.
13. Select **Save**. The label you entered will be displayed on the button.
14. Select **Done**. When you tap the button, the YouTube video should play.

Note: If you do not have a Wi-Fi connection when you attempt to play the YouTube video, the display area will be black and the following message will appear:

No Connection to YouTube
An internet connection is required to play a YouTube video.

If there is an internet connection but YouTube cannot be reached, the following message will appear:

No Connection to YouTube
YouTube appears to be blocked by your internet service provider. Please contact your network administrator.

Setting up a Button to Open an App

Note: This feature is not available in dedicated systems.

1. Go to the page that has the button you want to use and tap **Menu**.
2. Tap **Edit Page**. The page is now in Edit Mode.
3. Either tap or touch and hold the button you want to modify.
4. Select **Edit This Button**.
5. Give the button a label and scroll down to the Button Actions section.
6. Select **Add**. A list of available actions opens.
7. Select the action **Open App**. The Select App list opens.
8. Search for the app you want or scroll through the list.

To search for an app:

Select the search icon  on the right side of the Select App title bar or drag down on the list. A keyboard opens.

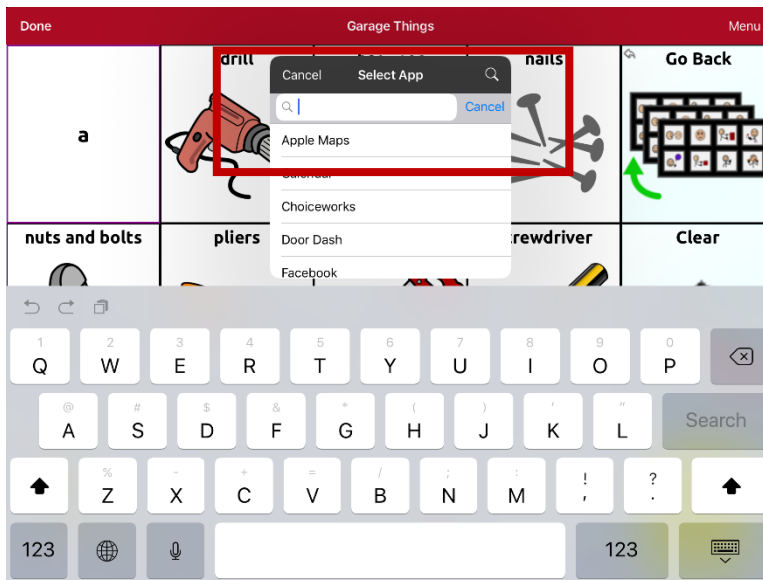

Enter an app name or partial app name. The search function searches for matches anywhere in an app name. For example, entering **ap** would display “**A**pple Maps”, “**G**oogle Maps”, “**S**napchat”, and “**W**hatsapp”.

9. Select the app you want and select **Save**.

Note: Make sure the app you select is installed on your device.

Verify that the button opens the app

1. Exit Edit Mode and tap the button. The app should open.

Note: If the app requires a login, be sure you have the login information available.

2. To exit the app and return to TouchChat, tap “TouchChat” in the upper left corner of the screen.

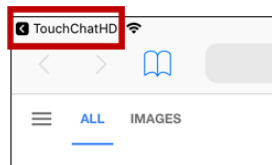

Note: If “TouchChat” does not appear in the upper left corner of the screen, press the device **Home** button and reopen TouchChat.

Searching Apps

Many apps include a search field that allows you to enter search criteria to find something within the app.

Using Spotlight Search

Spotlight Search not only searches your iPad, but also shows suggestions from the App Store and the Internet. You can also use Spotlight Search to find and open apps.

1. Drag down the middle of any Home screen to reveal the search field.
2. Type your search criteria. Results are displayed as you type.
3. To hide the keyboard and see more results on the screen, tap **Search**.
4. Tap an item in the list to open it.

Choosing Apps and Content to Search

By default, all apps and content listed under “Search Results” are selected for Spotlight Search. To deselect apps and content that you do not want included in searches, do the following:

1. Choose **Settings > General > Spotlight Search**.
2. Tap any apps or content that you do not want to include in searches.

Limiting Spotlight Search to Your iPad

1. Choose **Settings > General > Spotlight Search**.
2. Turn off **Spotlight Suggestions**.

Turning off Location Services for Spotlight Suggestions

1. Choose **Settings > Privacy > Location Services > System Services**.
2. Turn off **Safari & Spotlight Suggestions**.

Changing the iPad Language and Word Prediction Dictionaries

TouchChat provides American English, British English, and Spanish word prediction dictionaries. The device's Language settings determine which dictionary is used. Set up your device for the language you currently use. To select your language:

1. Choose **Settings > General**.
2. Select **Language & Region**.
3. Select **iPad Language**.
4. Select your language.

Setting up Restrictions

Setting up Restrictions on a Device Running iOS 12, iPadOS 13, iOS 13, or later

Set up restrictions to turn off access to Safari, YouTube, iTunes, installing apps, deleting apps, Location, In-App Purchase, etc. Also set restrictions on content (music, movies, and TV shows). To turn off items you would like to restrict, from the device:

1. Tap **Settings** and then tap **Screen Time** in the left pane.

Note: The first time you select Screen Time, a Screen Time window will appear. Tap **Continue** and select an option, depending whether the iPad is for yourself or a child. If you select the option for a child, follow the additional prompts.

2. Select **Use Screen Time Passcode** and create a passcode.
3. Tap **Content and Privacy Restrictions** and set up specific restrictions.

Note: At any time, you can disable screen time by selecting **Turn Off Screen Time**. If you turn screen time off, the restrictions you set up will also be turned off.

Setting up Restrictions on a Device Running iOS 11 or earlier

Use this feature to turn off access to Safari, YouTube, iTunes, installing apps, deleting apps, Location, In-App Purchase, etc. Also set restrictions on content (music, movies, and TV shows). To turn off items you would like to restrict, from the device:

1. Tap **Settings**, then **General**, and then **Restrictions**.
2. Tap **Enable Restrictions**.
3. Create a four-digit passcode.
4. Enter the passcode twice to set restrictions.

Attaching a Strap

If You Received Loops with Your Strap:

Your package included a strap and two loops for attaching the strap. Do not attach a strap directly to the plastic case as this may damage the device.



The loops are potential choking hazards. Use them with caution.

Decide whether you want to carry the unit in landscape or portrait orientation. Attach two loops to the appropriate side as shown.



Step 1: Feed the end of the loop through the hole in the case.



Step 2: Thread the metal ring through the loop.



Step 3: Pull the metal ring to tighten the loop.

Step 4: Attach the connectors on the ends of the strap to the metal rings on the loops.

If You Received Metal Rings with Your Strap:

Your package included a strap and two metal rings for attaching the strap. Do not attach a strap directly to the plastic case as this may damage the device. For devices that include a handle, simply attach the strap to the bottom holders if you remove the handle.



The metal rings are potential choking hazards. Use them with caution.

Decide whether you want to carry the device in landscape or portrait orientation. Attach two metal rings to the appropriate side as shown.



Step 1: Open the ring as you would open a key ring. *Suggestion:* Use your fingernail, a screwdriver, or a dime.



Step 2: Push the open ring onto the holder in the case.



Step 3: Allow the ring to close on the holder.



Step 4: Clip the shoulder strap to the ring.

Positioning the Stand

Your device comes with a stand that can be positioned for easy viewing. When closed, the stand is held in place by a latch.

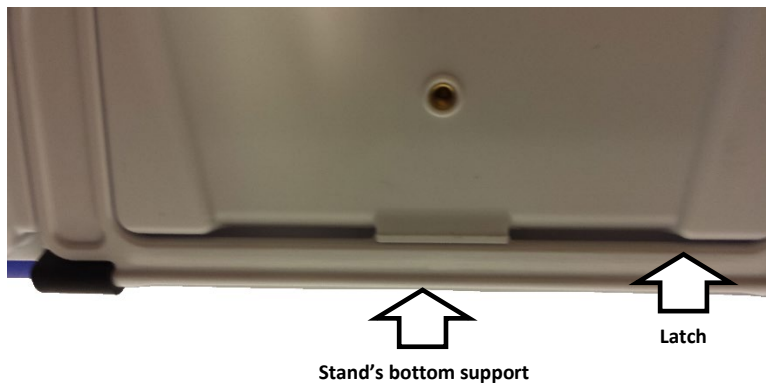

To position the device at an angle for easy viewing of the screen, do the following:

1. Place the device face-down on a flat surface.
2. While holding your thumb on the edge of the device below the stand's bottom support, press on the **inside** of the support with the tip of your index finger (or the tips of several fingers) to pull the support **away** from the latch.
3. Lift the support away from the back of the device until the legs latch into place. Then position the device.



Removing the Handle

If you do not plan to use the handle, you can remove it by removing the screws that hold it in place.



 The handle and screws are potential choking hazards.

Attaching a Wheelchair Mounting Plate

Three threaded holes are provided on the back of the device for attaching an optional wheelchair mounting plate. If you purchased the wheelchair mounting plate accessory, follow these instructions to attach the plate to your device.



1. Place the device face-down on a flat surface. Be careful not to scratch the display.
2. Align the three tapered holes in the mounting plate with the three threaded holes on the back of the device.

Important! Be sure that the mounting plate is oriented so that the additional hole for the holding pin is in the upper left.

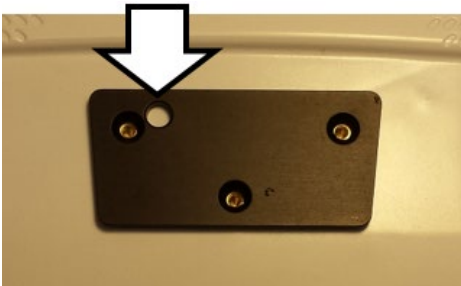

3. Insert and tighten the screws.

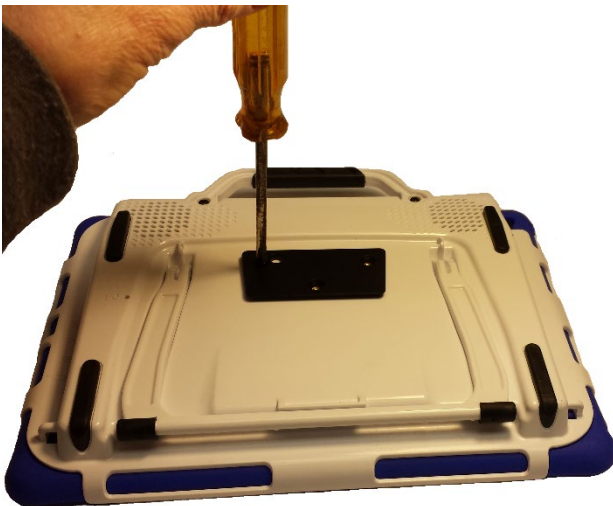

Replacing the Rubber Boot

To replace the rubber boot, follow these instructions.

1. Remove the existing plastic shell/rubber boot assembly from the device.
2. Remove the existing boot from the shell.
3. Fit one end of the device into the replacement rubber boot. Be sure to line up the buttons and ports on the device's sides with the corresponding receptacles and openings in the boot.

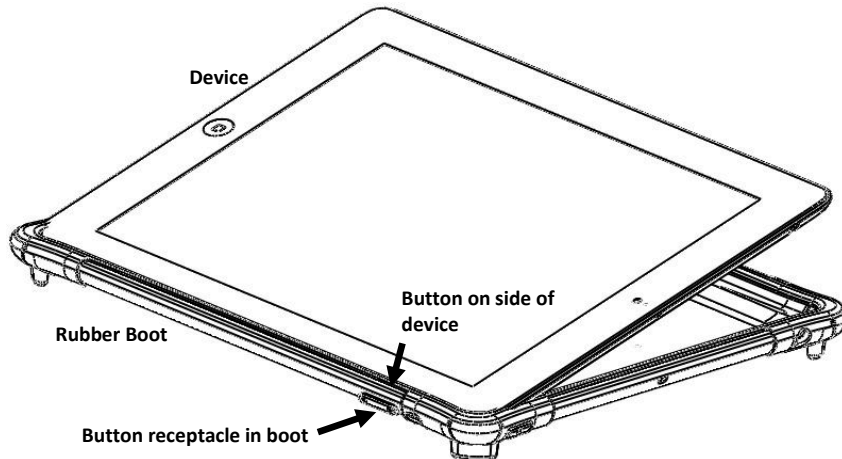

4. When you are sure that the device and boot are properly aligned, push the device down into the boot and pull the edges of the boot over the sides until the device is fully “wrapped” in the boot on all sides.
5. Fit one end of the device—wrapped in the boot—into the shell. Be sure to line up the buttons and ports on the device's sides with the corresponding openings in the shell.

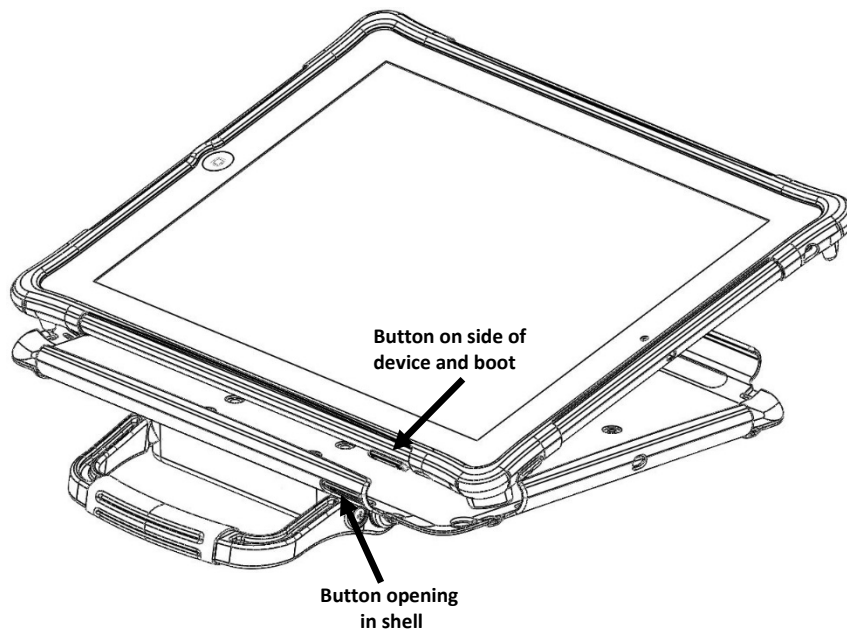

6. When you are sure that the device/boot assembly is properly aligned, carefully push each side into the shell until all sides snap into place.

Cleaning and Disinfecting Your Device

If your TouchChat Express will only be used by one person, routine cleaning and disinfecting should be sufficient. If, however, more than one person will be using the unit, take additional measures to clean and disinfect the unit after it has been used by one person before allowing it to be used by another.

Routine Cleaning and Disinfecting

Important! Do not use solvents or abrasives or spray water or cleaner on the unit.

Cleaning the touchscreen

The touchscreen is very sensitive. Fingerprint smears, dust, grime, saliva, etc. will affect its performance. The screen also reacts to raindrops and extremes in temperature (condensation).

To dust the touchscreen, use a soft, lint-free cloth. For heavier cleaning, use a slightly dampened, lint-free cloth and then dry the screen with another soft, lint-free cloth.

Cleaning the TouchChat Express components and keyguard

The unit can be disassembled and the TouchChat Express components and keyguard washed in hot, soapy water. Dry them thoroughly before reassembling the unit. The best practice for regular cleaning is to dry accessories by hand, lay them on a dry towel, and let them air dry for about 5 minutes before placing them back on the device.

Disinfecting

To disinfect everything but the display, use a solution of vinegar and water ($\frac{1}{4}$ cup vinegar to 1 cup water). Wipe the rubber boot (not the display) using a cloth dampened with this solution.

Wash the plastic shell and keyguard separately with the vinegar and water solution. Allow all equipment to air dry. **Do not use vinegar and water on the display!**

What about drooling/saliva?

Any saliva should be wiped up immediately, especially on the touchscreen or around any of the connectors. Use a slightly dampened, lint-free cloth to wipe the device.

What about spills, rain, or accidental immersion?

If you spill liquid or any runny substance on your TouchChat Express; if you are caught in a downpour; or if the unit is accidentally dropped in liquid, immediately dry the components as thoroughly as possible. Try using the device. If it does not work, call Saltillo technical support and tell them what happened. They may ask you to send in your device for servicing.

Disinfecting TouchChat Express and Accessories for Multiple Users

Note: This section applies only when more than one person will be using the same unit. In that situation, it is vital to effectively disinfect the unit and accessories that have been used by one person before allowing them to be used by another.

First Step: Put on protective gloves

Next Step: Clean the TouchChat Express components and accessories

1. Wipe down the TouchChat Express components and accessories with disinfectant wipes (Virucidal, Bactericidal, Pseudomonacidal, Tuberculocidal, Fungicidal)—Metrex CaviWipes™. Follow the disinfectant product manufacturer's instructions for *cleaning*.
2. Take a Q-tip with cleaner applied (for example, Windex® or another commercial cleaner) and clean inside all cracks and crevices. You may want to use a toothbrush or similar brush.
3. Blow the components off with an air hose, or wipe it dry.

Important! Make sure all soil is removed from the TouchChat Express components and accessories. This is vital before proceeding to disinfecting the equipment.

Next Step: Disinfect the TouchChat Express components and accessories

1. Wipe down the TouchChat Express components and accessories with a new disinfectant wipe (Virucidal, Bactericidal, Pseudomonacidal, Tuberculocidal, Fungicidal)—Metrex CaviWipes. Follow the disinfectant product manufacturer's instructions for *disinfecting*.
2. Make sure to clean inside all cracks and corners, and wipe more than once if necessary to keep the components wet for a minimum of three (3) minutes.
3. Allow the components and accessories to dry.

Final Step: Wipe the touchscreen

1. When the TouchChat Express components and accessories are dry, wipe down the viewing area (device touchscreen, keyguard, etc.) with glass cleaner, so the screen does not discolor.
2. Allow the equipment to dry.

Warranty

PRC-Salttillo warrants the TouchChat Express to be free from defect in material and workmanship under normal use for the device warranty period of one year from date of purchase.

Please contact Saltillo technical support (1-800-382-8622, option 1) prior to making alterations to the TouchChat Express for mounting, transportation, etc.

All warranty service should be arranged through PRC-Salttillo prior to sending a system back. Please call the company at 1-800-382-8622, option 1, or email at service@salttillo.com to obtain a Return Authorization number prior to sending the system to PRC-Salttillo.

If replacement is necessary, the replacement TouchChat Express may be a new or re-conditioned TouchChat Express of equal value.

Note: PRC-Salttillo considers bending of the unit, submerging it into liquid of any kind, or any breaks and/or cracks in the LCD screen to be misuse. However, PRC-Salttillo will cover one screen replacement or one iPad replacement per warranty year.

Shipping address:

PRC-Salttillo
Attn: (Insert RA # here)
1022 Heyl Road
Wooster, OH 44691

Appendix A: Advanced Grammar Features

The features explained in this appendix are intended for persons with extensive knowledge of grammar. Please note that this is an alternative way to set up grammar within a vocabulary file. WordPower files already have a grammar in place.

Creating a Grammar Button

To create a button that changes a word to a different grammatical form:

1. Go to the page with the button location you want.
2. Tap **Menu > Edit Page**.
3. Press and hold the button you want to use.
4. Tap **Edit This Button**.
5. Add a label. For example, enter **-s**.
6. Scroll down to the Button Actions section.
7. Tap **Add**.
8. Tap **Grammar Action**. The Grammar actions will be displayed.

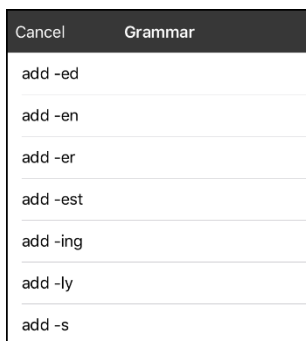



9. Tap the action you want. For example, tap **add -s**. The action will be listed in the Button Actions section.
10. Tap **Save**. In this example, a button labeled “-s” will be available to pluralize all nouns.

Identifying Parts of Speech

To apply a part of speech to a button:

1. Navigate to a page of “things” (nouns).
2. Choose **Menu > Edit Page**.
3. Press and hold a “thing” button (for example, **car**), choose **Edit This Button**, and scroll down to the **Actions** section.
4. Choose **Add** to open the list of actions.
5. Select **Apply Grammar Property**. The Part of Speech menu will list adjective, noun, and verb options.
6. Select the applicable part of speech (for example, **noun**).
7. Choose **Save**. In this example Apply Grammar Property (noun), will appear at the bottom of the list of actions defined for the button.

Important! The grammar property must appear first in the list of actions. You’ll need to move it to the top of the list.

8. Tap **Edit**. A delete icon  will appear in front of each action and gray bars  will appear to the right. Touch and hold the gray bars  to the right of the Apply Grammar Property (noun) action and drag it to the top of the list of actions.
9. Choose **Save**.
10. Repeat steps 3 through 10 for the remaining “thing” buttons on the page.

Creating a Grammar Rule Button

1. Press and hold the button you want to set up as a pluralize button, choose **Edit This Button**, enter a label for the button (for example “-s”), and choose the **Actions** tab.
2. Choose **Add** to open the list of actions.
3. Select **Apply Grammar State**. The Grammar menu will display a list of options.

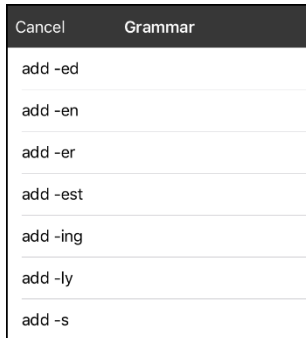

These options perform as follows:

Option	Application
add -ed	verb simple past tense
add -en	verb past perfect participle
add -er	adjective comparative
add -est	adjective superlative
add -ing	verb present participle/gerund
Add -ly	adverb
add -s	noun plural

4. Select the applicable option (for example, **add -s**).
5. Choose **Save**. In this example, Apply Grammar State (add -s) will appear in the list of actions defined for the button.
6. Remove any other actions that were already on the list.
7. Choose **Save**. In this example, a button labeled “-s” is now available to pluralize all words identified as nouns.

Using Your Grammar Rule Button

Place the grammar rule button on a page of applicable items. For example, place a pluralize button on a page of things (nouns). If you tap your pluralize button and then choose a thing, you will need to tap the pluralize button again before pluralizing another thing.

1. In the Speech Display Bar (SDB), enter the words you want to speak **up to** the thing you want to pluralize. For example, enter “I want more”.
2. Tap the “-s” button you created in the previous section, “[Creating a Grammar Rule Button](#)”.
3. Choose the thing button you want (for example, **car**). The SDB will display “I want more cars”.

Clearing a Grammar Rule

You may find it useful to create a Clear Grammar State button.

If you tap the pluralize button and decide you don’t want to pluralize a word on the current page, you can move to another page of things, select a noun from that page, and that noun will be pluralized.

If, however, you tap the pluralize button and decide you don’t want to pluralize any word, the software will pluralize the next noun you select unless you clear the pluralize state. In this case, after you tapped the pluralize button and then changed your mind, you would navigate to your Clear Grammar State button and tap it. From that point forward, nouns won’t be pluralized until you tap your pluralize button.

To create a button for clearing the current grammar state:

1. Go to the button you want to use and choose **Menu > Edit Page > Edit This Button**.
2. Give the button a label, scroll down to the Actions section, select **Add**, and select the action **Clear Grammar State**,
3. Remove any other actions that were already on the list.
4. Choose **Save**. This button will now clear any grammar state that has been activated.

Appendix B: Compliance Information

Federal Communications Commission (FCC) Warning

This device complies with Part 15 of the FCC Rules. Operation is subject to two conditions: (1) this device may not cause harmful interference, and (2) this device must accept any interference received, including interference that may cause undesired operation.

Changes or modifications to this product which are not expressly approved by PRC-Salttillo could void the user's authority to operate the equipment.

Note: This equipment has been tested and found to comply with the limits for a Class B digital device, pursuant to part 15 of the FCC Rules. These limits are designed to provide reasonable protection against harmful interference in a residential installation. This equipment generates, uses and can radiate radio frequency energy and, if not installed and used in accordance with the instructions, may cause harmful interference to radio communications. However, there is no guarantee that interference will not occur in a particular installation. If this equipment does cause harmful interference to radio or television reception, which can be determined by turning the equipment off and on, the user is encouraged to try to correct the interference by one or more of the following measures:

- Reorient or relocate the receiving antenna.
- Increase the separation between the equipment and receiver.
- Connect the equipment into an outlet on a circuit different from that to which the receiver is connected.
- Consult the dealer or an experienced radio/TV technician for help.

Industry Canada (IC) Warning

This device complies with Industry Canada license-exempt RSS standard(s). Operation is subject to the following two conditions: (1) This device may not cause interference, and (2) This device must accept any interference, including interference that may cause undesired operation of the device.

Le présent appareil est conforme aux CNR d'Industrie Canada applicables aux appareils radio exempts de licence. L'exploitation est autorisée aux deux conditions suivantes: (1) l'appareil ne doit pas produire de brouillage, et (2) l'utilisateur de l'appareil doit accepter tout brouillage radioélectrique subi, même si le brouillage est susceptible d'en compromettre le fonctionnement.

Wireless Communications Equipment

Wireless communications equipment such as wireless home network devices, mobile phones, cordless telephones and their base stations, and walkie-talkies can affect this device and should be kept a least six (6) inches away from the device.

Limitation of Intended Use, Third Parties, and Data Loss

- PRC-Salttillo does not warrant any functionality of this speech generating device outside the terms of its express warranty relating to the intended use of speech generation. PRC-Salttillo does not warrant any third-party software, nor is it responsible for any injury, damage or claims arising from the function or malfunction of any third-party technology, websites, products, and software. Additional uses may require further clinical determinations beyond the scope of an evaluation for speech generation devices.
- PRC-Salttillo assumes no responsibility for any loss or claims by third parties which may arise through the use of this product.
- PRC-Salttillo assumes no responsibility for any damage or loss caused by the deletion of data as a result of malfunction repairs or battery replacement. Be sure to back up all important data on other media (computer) to protect against its loss.

Device Intended Purpose

TouchChat Express is a speech generating device that augments communication for an individual with speech/language impairment. This device and its language programs give the user the ability to initiate conversation, seek information, state opinions, and share feelings. It can be hand-held, used with a table stand, or mounted to a wheelchair. It is accessed by using the touchscreen or a variety of available switch accessories. The device does not incorporate in any way medicinal substances, human blood or plasma derivatives, nor is it manufactured using tissues of animal origin.

Expected Service Life

The expected service life of the device, battery charger, and accessories is five years. If you dispose of your device, battery charger, or accessories, please dispose of them in accordance with your local, state, and/or country electronic recycling laws.

Intended Operators

The individual using the device to communicate, the individual's communication partner, and/or the person changing device settings, maintaining software files, etc. are the intended operators of the device. The pictures and text in this document will help these operators achieve the intended use of the device.

Expected Position of Operators

In normal use, the device is expected to be within 12 to 14 inches of the individual's body. The distance will vary according to whether the device is hand-held or mounted on a wheelchair or table.

Special Skills, Training, or Knowledge Required

No special skills or training are required to operate or maintain the device. The pictures and text in this document will help the operators acquire the knowledge to achieve the intended use of the device.

Instructions for Use

- All functions of the device are safe for use by the user. For best results, follow the instructions in this manual.
- There is no need to turn the device or amplifier off when using the device on a daily basis. It is recommended to restart the device once per week and put it to sleep daily.
- To report any serious incident associated with the device, contact PRC-Salttillo and your national authority.
- For information on cleaning the device, see “Cleaning and Disinfecting Your Device”.

Contact Information for Assistance











If you need assistance in setting up, using, or maintaining your device or if you need to report unexpected operation of the device or an unexpected event related to the device, please contact us by phone at 1-877-872-1428 or by email at service@salttillo.com.

Instructions for Storage

If you will be leaving the device in storage for a long period of time, turn the device and amplifier off. Devices in storage must be charged every six months.

Explanation of Symbols

This section explains the symbols that appear on NovaChat devices, accessories, or packaging.

Symbol	Explanation
	The device is Federal Communications Commission (FCC)-compliant.
	Recycle electronic equipment. Do not throw the device in the trash.
	The device conforms to European Union health, safety, and environmental standards.
	The entire device and accessories, excluding the adapter, are type BF applied parts. “Applied part” refers to the part of the device with which the user comes into physical contact when using it for its intended function.
	The device emits generally elevated, potentially hazardous, levels of non-ionizing electromagnetic radiation.
	Caution! Use caution when operating the device to avoid undesirable consequences.
	Keep dry. The device needs to be protected from moisture.
	Consult instructions for use.
	The date of manufacture of the device and the name and address of the manufacturer.
	The authorized representative in the European Community.

Classifications: TouchChat Express 8 and TouchChat Express 10

Note: The TouchChat Express 10 device is no longer manufactured.

Protection against electrical shock	Class II / internally powered
Mode of operation	Continuous
Type of applied part	BF

Specifications: TouchChat Express 10

Note: The TouchChat Express 10 device is no longer manufactured.

Weight	1.95 lbs.
Dimensions	9 11/16 in. x 6 15/16 in. x 1 ¼ in.
Battery life	10-12 hours, depending on individual usage and power settings
Software/operating system	Various apps/iPadOS or iOS
Standard components	Amplifier, handle, stand, boot, battery charger/USB cable, stylus
Accessories	Keyguards, TouchGuides, wheelchair mounting plate, backpack carrying case, shoulder strap, waist belt, strap attachments

Operating Environment

Ambient temperature	5°C to 40°C (41°F to 104°F)
Relative humidity	15% to 93%, non-condensing
Atmospheric pressure	70 kPa to 106 kPa
The device needs to be protected from moisture during use.	

Transport and Storage Environment

While in transport or storage, the range of temperatures to which the device can be exposed is -25°C (-13°F) without relative humidity control to 70°C (158°F) at a relative humidity up to 93%, non-condensing, with an atmospheric pressure range of 70 kPa to 106 kPa.

Temperature Conditions for Direct Contact

At an ambient temperature of 40°C (104°F), the surface temperature of the back of the device can increase as much as 11°C (51.8°F) during charging to a temperature of 51°C (123.8°F). For this reason, minimize contact with the back of the device while the device is charging.

- ⚠ While the device is charging, touching the surface of the device with broken skin may aggravate a wound.
- ⚠ While the device is charging, infants or high-risk groups should not touch the surface of the device if there is a chance of burning the skin.
- ⚠ While the device is charging, minimize contact with the back of the device.